

WOODWAY®

For The Long Run®

**4FRONT - Med Series
Owners Manual**



4FRONT MED / PRO MED / PRO XL MED

**Standard and Gas Assist Handrail Models
Quickset and Personal Trainer Control Consoles**

OM 01.001 Rev. 5
4Front Med Series Owner's Manual
A4 Format



woodway.com

Note: If viewing this manual using Adobe Acrobat Reader, "Clicking" on the **Blue Chapter Headers** in the Table of Contents will take the reader to the Main Chapter Pages.
 Clicking on the Small **Blue WOODWAY Logo** in the upper corner of each page will return the reader to the Table of Contents.
 All other text and elements shown in **Blue** are Hyperlinks that will take the reader to the specified highlighted Blue call-out.



Read these instructions carefully before beginning any maintenance or service on the treadmill.
Follow ALL Safety protocols and Lock-Out Tag-Out (LOTO) directives.

Copyright 2025 ©
 The release of the service instructions to third parties without the written permission of WOODWAY is prohibited. No portion of this content in any manner and form - including excerpts - photos - drawings - as well as use and/or communication of the content is not permitted without written permission from WOODWAY® USA, Inc.
 Except as permitted by U.S. copyright law.

NOTICE

All contents, text, drawings, images, or other illustrations are copyright protected and are subject to intellectual property rights. Any misuse is punishable by law.



Manufacturer

WOODWAY USA, Inc.
 W229 N591 Foster Ct.
 Waukesha, WI 53186
 USA
 Tel.: 1-262-548-6235
 Fax.: 1-262-522-6235
 E-mail: info@WOODWAY.com
 Web: www.WOODWAY.com

Technical Support:
 Tel.: 1-800-WOODWAY Ext 3
 E-Mail: service@woodway.com
 SRN: US-MF-000031568



European Representative

WOODWAY GmbH
 Steinackerstr. 20
 79576 Weil am Rhein
 Germany
 Tel.: + 49 (0) 7621-940 999-0
 Fax.: + 49 (0) 7621-940 999-40
 E-mail: info@WOODWAY.de
 Web: www.WOODWAY.de

Sales:
 Tel.: +49 (0) 7621 - 940 999 - 10
 E-Mail: vertrieb@woodway.de

Customer Service:
 Tel.: +49 (0) 7621 - 940 999 - 14
 E-Mail: service@woodway.de
 SRN: 000009530



EU - Importer

WOODWAY GmbH
 Steinackerstr. 20
 79576 Weil am Rhein
 Germany
 Tel.: + 49 (0) 7621-940 999-0
 Fax.: + 49 (0) 7621-940 999-40
 Web: www.WOODWAY.de
 SRN: DE-IM-000009533

Table of Contents

1	Safety.....	11
1.1	Important Safety Instructions.....	11
1.2	Electromagnetic Compatibility (EMC)	14
1.3	Description of Warning Notices.....	16
1.4	Safety Notices on Device.....	16
1.5	Personnel Qualifications and Responsibilities.....	19
1.6	Intended Use	19
1.6.1	Health Risks	20
1.6.2	People with Medical Conditions.....	21
1.6.3	Pregnancy	21
1.6.4	Symptoms During Training	21
1.6.5	Contraindications	21
1.7	Unauthorized Modes of Operation	22
2	Introduction	24
2.1	Operating Instructions Information.....	24
2.2	Limitation of Liability	25
2.3	Copyright.....	25
2.4	Replacement Parts	25
2.5	Customer Service:.....	26
2.6	UL Certification	27
3	Dimensions and Technical Specifications ..	27
3.1	Product Line Overview	27
3.2	RS-232 Interface	28
3.3	Name Plates:.....	28
3.4	Dimensions	30
3.4.1	4 Front Med Model.....	30
3.4.2	4 Front Pro Med Model	31
3.4.3	4 Front Pro XL Med Model	32
3.4.4	4 Front Med Gas Assist Parallel Handrail (GAPH)	33

3.5	Conditions for Use	34
3.7	Electrical Connections	34
3.7.1	North America	35
3.7.2	Europe	36
3.7.3	United Kingdom	36
3.7.4	Toroidal Power Transformer.....	37
3.7.5	Grounding Information	37
3.7.6	Grounded Outlet Information.....	38
4	Transportation and Storage	39
4.1	Safety Notices for Transportation	39
4.2	Flat Transportation	39
4.3	Upright Transportation.....	39
4.4	Transportation with Carrying Poles	40
4.5	Storage.....	40
5	Product Description / Overview.....	41
5.1	Running Surface.....	41
5.2	Transport System.....	41
5.3	Incline System	42
5.4	Dynamic Mode (Overview)	43
5.5	Power/Main Fuse Console - ON/OFF	43
5.6	Safety Equipment	43
5.6.1	Safety Handrail.....	44
5.6.2	Emergency Stop Pull-Cord	44
5.6.3	Belt Drive Current Limiting.....	45
5.6.4	Low Leakage Current	45
5.6.5	Dismounting in Emergency Situations	45

6	Setup and Placement	46
6.1	General	46
6.2	Preparation and Placement	47
6.3	Safe Fall Area	48
7	Installation Instructions	49
7.1	Leveling Instructions	49
7.3	4 Front Med Series Dis-Assembly /Assembly.....	54
7.4	Gas Assist Handrail Overview.....	57
7.4.1	Control Adjustments	57
7.4.2	Front Cross Bar Adjustment.....	58
7.4.3	Side Handrail Adjustments.....	59
7.5	Completion of Installation.....	61
8	Operation	61
8.1	For Your Safety	61
8.2	Practical Training.....	62
8.2.1	Professional Consultation	62
8.2.2	Warm-Up and Cool Down	63
8.2.3	Proper Body Form.....	63
8.2.4	Rehabilitation / Training Frequency	63
8.2.5	Measuring Heart Rate	64
8.2.6	Calculating Heart Rate Measurement	64
8.2.7	Contact Heart Rate Monitors.....	65
8.2.9	Applying the Chest Strap	66
8.2.10	Transmitter Function	67
9	Quick Set Display	68
9.1	Overview of Control Console	68
9.2	Starting/Finishing a Workout.....	72
9.3	Dynamic Mode.....	72
9.4	Saving Workouts to USB	73

9.5	Uploading Data to Computer.....	73
9.6	Excel Importing.....	73
10	Personal Trainer Display	74
10.1	Overview of Control Console	74
10.2	LCD Display Overview	78
10.3	Quick Start Operation.....	79
10.4	Manual Mode with Weight Input	80
10.5	Dynamic Mode.....	81
10.6	Starting a Training Program.....	82
10.7	Fitness Programs.....	82
10.7.1	Heart Rate Control Program.....	85
10.7.2	Goal Program.....	88
10.7.3	Weight Loss Program.....	90
10.7.4	Aerobic Program.....	92
10.7.5	Interval Program	94
10.7.6	Random Program	96
10.7.7	Stamina Program.....	98
10.7.8	Ramp Program.....	100
10.7.9	5 K Program	102
10.7.10	10 K Program	104
10.7.11	User Programs	106
10.8	Fitness Tests.....	110
10.8.1	Balke Program.....	110
10.8.2	Gerkin Program	112
10.8.3	Copper Program	114
10.8.4	Rockport Program	115
10.9	Military Test Programs.....	116
10.10	Saving Workouts to USB	118

11	Options and Accessories	119
11.1	Power Input 208/230 V	119
11.2	Reverse Mode - Bi-Directional Belt Control (US Models Only)	119
11.3	Top Speeds Upgrade.....	120
11.4	RS-232 Remote Computer Control.....	120
11.5	Accessories and Services	120
12	Cleaning/Disinfection/Maintenance	121
12.1	Cleaning	121
12.2	Maintenance Intervals.....	124
12.3	Maintenance Access Standard Handrail	128
12.4	Maintenance Access Medical Handrail	129
12.5	Lubrication.....	130
12.5.1	Bearings.....	130
12.5.2	Running Surface Belt, Drive Axle	132
12.5.3	Drive Belt	132
12.5.4	Incline System	133
12.5.5	Control Console Support.....	134
12.6	Adjusting and Calibrating	134
12.7	Disabling the Treadmill	135
12.8	Device Fuses	137
13	Troubleshooting	137
13.1	Unusual Noises	138
13.2	No Display.....	138
13.3	Running Surface Does Not Move.....	139
13.4	Free Moving Running Surface.....	139
13.5	Incline Does Not Function.....	139
13.6	Irregular or Flashing Display.....	139
13.7	Sources of Electromagnetic Interference	140
13.8	Interference of POLAR® Heart Rate Monitor	140

14 Replacing Parts 141

15 Warranty Information 142

16 Maintenance Report Logs..... 143

17 Worksheets 145

18 Disposal..... 146

My WOODWAY _____ Arrived on _____
Model Name Date

WOODWAY History

WOODWAY's history begins in Germany in 1974. Willi Schoenberger, a technical director in charge of planning a fitness center, noticed that the most important piece of equipment, the treadmill, didn't meet the most important requirements: a mechanically sound machine that is designed to meet human needs.

He envisioned a comfortable walking surface that didn't interfere with the natural bio-mechanics of running or walking. Also, he wanted a transportation system which eliminated the friction associated with conventional conveyor-belt treadmills. After intensive research, and trial and error (and in cooperation with the Deutsche Sporthochschule in Cologne, Germany), Willi developed and patented a very unique and revolutionary treadmill design.

In 1975, WOODWAY GmbH was founded in Weil am Rhein, Germany. The name "WOODWAY" is derived from the German "Waldweg" ("Wald" = wood and "Weg" = way), the feel of running on a soft pine needle covered path in the forest.

In 1983, a manufacturing license was awarded to Sakai Medical, for the use of WOODWAY technology in the Japanese marketplace.

In 1988, a U.S. license was granted to a small, well-established manufacturing company in Waukesha, Wisconsin. WOODWAY USA was formed when the U.S. incarnation of the WOODWAY was developed and completed in 1990. WOODWAY USA is proud to be the primary manufacturer of WOODWAY treadmills worldwide, exporting treadmills for international distribution, in addition to serving our domestic customers and clients.

Today, WOODWAY's design and manufacturing facilities in the United States, Germany, and Japan make WOODWAY the largest specialized treadmill manufacturer in the world. Constant enhancements in quality, design, and function are shared and implemented by all three WOODWAY manufacturers.

As WOODWAY moves forward, attention to product quality, innovation, and customer service are at the forefront of our efforts. Along with our treadmills, other products, services, and strategic relationships are being developed to keep WOODWAY on the leading edge as we meet fitness training, testing, and rehabilitation needs.

1 Safety

1.1 Important Safety Instructions

The treadmills have been reliably designed, manufactured, and tested according to the latest state of technology and are in safe and technically perfect condition.

Nevertheless, the devices can cause risk to persons and property if operated improperly.

For this reason, the operating instructions should be read completely and safety instructions must be observed.

Warnings attached directly to the device must be observed and kept in a legible condition. Inappropriate use will result in the rejection of any liability or guarantee claims by WOODWAY.

All WOODWAY treadmills are built to the specifications of and are intended for both commercial and residential use.

Read ALL instructions before using the treadmill.

DANGER - To reduce the risk of electrical shock:

- Do not modify the plug provided with the treadmill. It is equipped with a grounded power cord. If it will not fit in the outlet, have a proper outlet installed by a qualified electrician.
- Do not use any adapters, especially those without grounding provisions. Doing so could potentially result in electrical shock.
- Do not operate motorized treadmills in damp or wet locations.
- Do not operate the heart rate monitor transmitter in conjunction with an electrical heart pacemaker. The transmitter may cause electrical disturbances.
- Always unplug the treadmill immediately after using and before cleaning or servicing.
- Do not soak the treadmill surfaces with any liquid; use a sprayer or damp cloth.
- Keep all electrical components, such as motor, power cord, and power switch away from water.
- Do not place any open liquid containers on any part of the treadmill. The use of sport bottles with close-able tops is acceptable.
- Do not attempt to service your treadmill yourself without first contacting WOODWAY Service.
- Always keep the running surface clean and clear of obstructions.

CAUTION:

- Consult your physician before beginning any exercise program, especially if any of the following pertain to you: history of heart disease, high blood pressure, diabetes, chronic respiratory disease, elevated cholesterol, smoker, experiencing any other chronic disease or physical impairments.
- Pregnant women should consult their physician before beginning an exercise program.
- If you experience dizziness, chest pain, nausea, or any other abnormal symptoms while using the treadmill, stop training immediately. Consult a physician before continuing.
- A qualified mechanic should perform any service or repair work. It is preferable that mechanics have successfully completed WOODWAY factory-authorized service school or equivalent.

WARNING - To reduce the Risk of burns, fire, electric shock or injury to persons:

- Never operate this appliance if it has a damaged cord or plug, if it is not working properly, or if it has been damaged. Contact WOODWAY or authorized service agent for servicing or assistance.
- Do not operate under blanket or pillow. Excessive heating can occur and cause fire, electric shock, or injury to persons.
- Dynamic Mode- The treadmills have the ability to be used in a free-wheel (non-motorized) mode. This allows the user to manually control the speed of the belt and disengages the belt. Never leave the treadmill in Dynamic Mode, as users unaware of freewheel mode may inadvertently accelerate the belt.
- If the treadmill is stopped while in use at an incline (e.g. Safety lanyard pulled, loss of power, On/Off Main Power Switch turned OFF, etc.) the belt may freewheel. The user's weight and gravity can lead to inadvertent belt acceleration.
- If the On/Off Main Power Switch of the treadmill is in the OFF position, the running belt will be disengaged and in a freewheel mode. Do not mount/use the treadmill when the ON/Off main switch is OFF.
- Always press the STOP button to end the workout.
- Keep the cord away from heated surfaces.
- Never operate the appliance with the air openings blocked. Keep the air openings free of lint, hair, and the like.
- Never drop or insert any object into any opening.
- Never leave the treadmill unattended while a workout is in progress.
- Do not operate where aerosol (spray) products are being used or where oxygen is being administered.
- Set up and operate the treadmill on a solid, level surface.

- Use the treadmill only for its intended purpose as described in the manual.
- Do not use attachments not specified by the manufacturer.
- The treadmill should never be left unattended when plugged in. Unplug the treadmill from the outlet when not in use and before cleaning or servicing.
- Do not operate the treadmill outside.
- To disconnect the treadmill, turn all controls to OFF position then remove the plug from the outlet.
- Connect the treadmill to a properly grounded outlet only. See Grounding Instructions.
- Keep all loose clothing and towels away from the running surface. It is also important that shoe laces do not extend beyond the bottom of the shoe.
- Keep the area behind treadmill clear and at least 78" (2 m) from walls or furniture.
- Keep hands away from all moving parts.
- Never leave children unsupervised while on or near the treadmill.
- Inspect the treadmill for worn or loose components prior to use. Tighten or replace any worn or loose components prior to use.
- Read, understand, and test all emergency stop procedures.
- Always use the emergency safety pull cord supplied with the treadmill. It can be clipped to an article of clothing while training. This is for the user's safety in case of an emergency.
- WOODWAY treadmills are built to handle runners weighing up to 800 lbs. (360 kg) at speeds between 0-4 MPH (0-6.5 km/h) and 400 lbs. (180 kg) at speeds greater than 4MPH (6.5 km/h).
- The treadmill running belt might not stop immediately if an object becomes caught in the belt or rollers.
- WOODWAY recommends that facilities utilizing high speed/over-speed training applications or special applications, or those that have users who are elderly, are children, or have health limitations, use a safety gantry harness.
- The manufacturer declines any liability for personal injury and/or property damage which could have been avoided with the use of a gantry harness system.
- Care should be taken when mounting and dismounting the treadmill. Never mount or dismount the treadmill while the running belt is moving. Use the handrails and handlebar whenever practical or necessary.
- Wear proper athletic shoes with rubber or high-traction soles. Do not use shoes with heels or leather soles. Ensure no stones are embedded in the profile of the soles.
- Allow several minutes to bring your heart rate into the training zone depicted in the manual. Walk slowly after your workout to allow your body sufficient time to cool down and your heart rate to decrease.

- The safety and integrity designed for the machine can only be maintained when the treadmill is regularly examined for damage and/or wear and repaired if necessary.
- It is the sole responsibility of the user/owner or facility operator to ensure that regular maintenance is performed.
- Worn or damaged components should be replaced immediately or the treadmill should be removed from service until the repair is made. Only manufacturer supplied or approved components should be used to maintain and repair the treadmill.
- This appliance is not intended for use by persons with reduced physical, sensory or mental capabilities, or lack of experience and knowledge, unless they have been given supervision or instruction concerning use of the appliance by a person responsible for their safety. Keep children under the age of 13 away from this machine.

1.2 Electromagnetic Compatibility (EMC)

It is expressly noted that WOODWAY 4 Front Med treadmills are subject to special precautions regarding electromagnetic compatibility (EMC). They must be installed and operated accordingly.

It should be noted that portable and mobile RF communications equipment and other devices with interference beyond permissible values can affect the electronics of the treadmill. This can influence the measurement functions and the displays, causing malfunctions.

ATTENTION		BA10
<p>According to CISPR 11, the treadmill is a Class A device.</p> <p>The device can cause radio interference or disrupt the operation of equipment in the vicinity. It may be necessary to take appropriate remedial measures, such as changing the direction, realigning or shielding the device, or filtering the connection to the location.</p>		

A facility safety sign is intended to prompt users to read the warnings on the equipment, obtain instructions on use, and be alert to the potential for injury when using or being near fitness equipment.

NOTE: A safety sign has been included with your treadmill. It is the responsibility of the owner to post this sign in a visible area near the machine.

Note: Please place the safety sign in a prominent location in your facility.

Recommended locations include locker room doors and doors leading into the fitness equipment room. The purpose of this sign is to reiterate and draw attention to the potential hazards present in all fitness equipment. It is not intended to substitute for the general warning label or site-specific labels.

SAFETY FIRST

THE FITNESS EQUIPMENT IN THIS FACILITY PRESENTS HAZARDS WHICH, IF NOT AVOIDED, COULD CAUSE SERIOUS INJURY OR DEATH.

PRIOR TO USING THIS EQUIPMENT, READ THE WARNING LABELS AND INSTRUCTIONS AFFIXED TO EACH MACHINE.

IF YOU ARE UNSURE OF HOW TO USE A MACHINE, SEEK ASSISTANCE.

IMMEDIATELY REPORT ANY PIECE OF EQUIPMENT THAT IS NOT FUNCTIONING PROPERLY TO OUR STAFF SO IT MAY BE EVALUATED AND SERVICED PROMPTLY.

DO NOT ATTEMPT TO USE OR FIX ANY PIECE OF EQUIPMENT THAT IS NOT FUNCTIONING PROPERLY.

WHILE USING THIS TREADMILL, THE SAFETY LANYARD MUST BE WORN AT ALL TIMES.

MAKE SURE SHOES ARE TIED TIGHTLY AND LACES DO NOT FALL BELOW THE BOTTOM OF THE SOLE TO AVOID FALLING.

DRINK PLENTY OF LIQUIDS. IF FEELING FAINT, STOP USE IMMEDIATELY.

ASTM F1749

1.3 Description of Warning Notices

Warning notices indicate potential hazards or safety risks. They are indicated in this manual by a color-coded signal word panel (symbol with the appropriate signal word). All warning notices have the same design and the same standardized content design.

Sample of a Warning Notice

 SIGNAL WORD
<p>Warning Text, Type, and Source of Danger</p> <p>Description of the consequences of ignoring the danger</p> <ul style="list-style-type: none"> • Measures, instructions, and forbidden actions to avoid the hazard. • Further measures.

Classification

NOTICE	<p>NOTICE or ATTENTION: (No Danger Symbol) No risk of injury, pertinent information and warning against material damage.</p>
 CAUTION	<p>CAUTION: (with danger symbol) light possibility of injury.</p>
 WARNING	<p>WARNING: (with danger symbol) In a dangerous situation, serious accident possible with the possibility of injury or death.</p>
 DANGER	<p>DANGER: (with danger symbol) In the event of an accident, immediate danger of death or serious injury.</p>

1.4 Safety Notices on Device

The treadmills are equipped with the following listed safety markings. Replace the safety stickers if they become damaged or illegible. Safety-relevant information is identified using the following stickers:

Protective Ground Wire Connection: Motorized treadmills are electrical devices in Protection Class 1.

Proper ground wire connection must be ensured.

This Notice is located inside the housing of the treadmill.

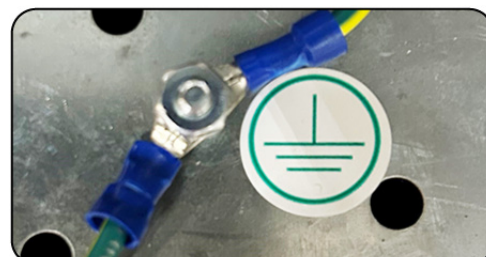

Warning Power Disconnect: Located on the lower right-side Cover, to Disconnect from Main Power supply prior to removing side cover.
P/N - M-1366-0

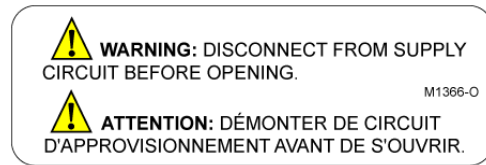

Warning on Power Cord: To reduce the risk of injury from moving parts, unplug the treadmill before servicing. Use time-delay fuses if applicable.

Located on the Main Power Cord.



Warning Emergency OFF Magnet: If the device is not in use, the EMERGENCY OFF magnet with safety line and clip are to be stored out of the reach of children.

Located on the Lower Front of the Main Control Panel.



Warning Emergency OFF Magnet: If the device is not in use, the EMERGENCY OFF magnet with safety line and clip are to be stored out of the reach of children.

Located on the Lanyard Cord.

P/N - M-1369-0

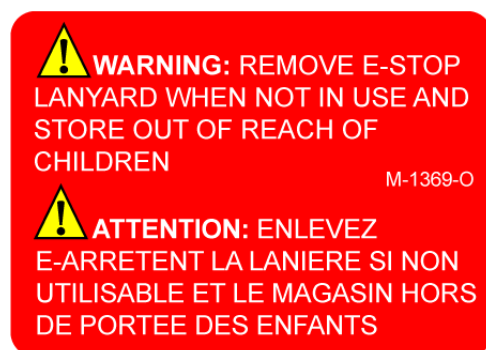

Safety Notice for Fuse Change: To prevent fire hazard, only replace fuses with the same type and power fuses. Remove the device from the main power source before changing.

This notice mis located to the left of the fuse panel. P/N - M-1368-0

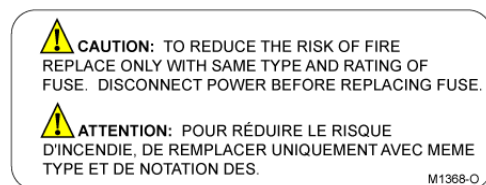

Warning on Power Cord: To reduce the risk of injury from moving parts, unplug the treadmill before servicing. Use time-delay fuses if applicable.

Located on the Main Power Cord.

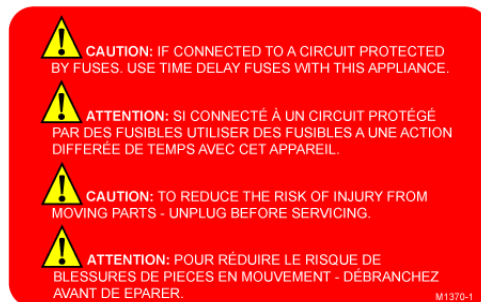

Warning to NOT Tension Belt: To prevent incorrectly tensioning running belt and causing damage or injury, call WOODWAY for proper instruction or to set up an appointment with a service technician.

Located just inside both treadmill side covers.



California Proposition 65 Warning:

Warning: Cancer and Reproductive Harm -
www.P65Warnings.ca.gov
P/N - 30-010327

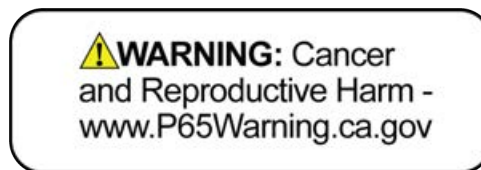

Warning Handrail Post Warning:

Warning: Adjust height of both handrail post before locking rotation

Failure to follow instructions may lead to damage of handrail posts.

P/N - 10-011424



1.5 Personnel Qualifications and Responsibilities

 WARNING 01	
Danger due to Improper Use! Improper handling of the device can lead to serious personal injury and property damage.	
<ul style="list-style-type: none">• The device may only be operated by persons who have received instructions from qualified service personnel.• WOODWAY recommends the use of a training record for proof of instruction.	

Representative: The representative is the person or company that is responsible for setting up, using, and maintaining the device.

The representative of the treadmill is responsible for regular maintenance and testing as required by law.

They are also obligated to provide adequate training/instruction to the operating personnel.

WOODWAY recommends the training be carried out by a trained and authorized WOODWAY dealer or service partner.

Operator: Operators of treadmills for medical applications are persons who use the device and have the “power of control” over the device.

This can be a therapist, sports physician, or any other supervisor.

The operator of a medical device is any person who - regardless of qualifications - independently uses a medical product in the commercial sector.

The operator is personally responsible for the safety of the user (e.g. patient, test subject, athlete).

Due to the high degree of responsibility these people have a special obligation to provide information on all aspects of safety of the device and its intended use.

1.6 Intended Use

 WARNING 02	
Danger due to Improper Use! Any improper use and/or other use of the device can lead to dangerous situation with significant personal injury and/or property damage.	
<ul style="list-style-type: none">• Only use the treadmill for its intended use.• Avoid excessive training, as this can lead to injury.• Read and strictly adhere to all information in the operating instructions.	

The intended use is to improve cardiovascular performance, strengths, and overall physical performance through the continued use of the medical treadmill under standard conditions of repetitive standing and normal walking or running movements at individually set speeds and elevation.

Woodway treadmills provide medical professionals with a controlled walking/running surface, which serves as the environment for applying an array of therapies or rehabilitation exercises.

This usage is commonly found in the following medical applications. Gait training and gait corrections, exercise therapy /rehabilitation training (locomotion therapy) performance, endurance and fitness training.

The operating instructions are an integral part of the treadmill and are to be available to all users at all times. The exact observance of the instructions is a prerequisite for the intended use of the WOODWAY treadmill.

 WARNING 010	
<p>Risk of Injury Through Risk of Falling!</p> <p>The motorized treadmill presents the danger of falling.</p> <ul style="list-style-type: none">• Familiarize yourself with treadmill operation and operating principles before the first training.• Always use the safety handrail when mounting and dismounting and when starting training.	

ATTENTION BA6	
<p>Claims to the manufacturer of any kind due to damage from improper use are excluded.</p> <p>The representative alone is liable for all damages resulting from improper use.</p>	

1.6.1 Health Risks

NOTICE BN3	
<p>CONSULT A DOCTOR!</p> <p>If you are over 40 years old, have a heart condition, are overweight, or have not been involved in an exercise program for several years, a visit to the doctor is recommended before beginning an intensive training program.</p>	

1.6.2 People with Medical Conditions

1. Before beginning an exercise program, consult your physician, especially if any of the following apply to you.
2. History of heart disease
3. High blood pressure
4. Diabetes
5. Chronic respiratory illness
6. Elevated cholesterol levels
7. Smoker
8. Other chronic illnesses or physical impairments

1.6.3 Pregnancy

It is recommended that pregnant women consult a physician before starting a training program.

1.6.4 Symptoms During Training

Should you experience dizziness, chest pain, nausea, or any other abnormal symptoms while training, stop training immediately. Consult a physician prior to continuing training.

1.6.5 Contraindications

1. There are a number of contraindications in the context of the relevant fields of treadmill use. In rehabilitation only the medical staff can determine the form and extent of therapy. Medications can have an influence on the rehabilitation (e.g. neuroleptics, benzodiazepines, barbiturates, antiepileptics, etc.).
2. For applications in "endurance training", "diagnostics and performance testing of patients", "performance diagnostics" and "stress tests" the same contraindications apply (among others) as with all physical stress. If there is doubt, it is important that a physician be consulted before using the treadmill.
3. Possible contraindications are acute myocardial infarction or unstable angina pectoris (stress test), cardiovascular diseases such as severe high blood pressure at rest, carditis, congestive heart failure, severe valvular heart disease, dangerous heart arrhythmias at rest or aortic aneurysm.
4. Acute illnesses, febrile conditions and newly occurring pain represent an absolute contraindication for physical stress. The feasibility of a training program for patients with chronic illnesses cannot be decided a priori and requires an accurate assessment of the risks and potential benefits.

5. In some situations (especially in patients with coronary heart disease or lung disease) overstraining can lead to an acute intensification of the patient's symptoms, so that an exercise ECG is essential, and training is only possible under medical supervision.
6. In the following cases treadmill training may only be carried out after consultation with a doctor: Pregnancy, acute thrombosis, fresh wounds (e.g. after surgery), artificial joints or prosthetics, bone fractures, spinal disc damage, traumatic injury to the spine, diabetes, epilepsy, inflammation, acute migraine headache, and cancer.
7. The use of the automated operation (pulse automatic, preset programs, external control via computer or other device) is prohibited, unless the strain was authorized by a physician in accordance with the patient's capacity/health.

1.7 Unauthorized Modes of Operation

The treadmill may only be used for the aforementioned intended use. Any additional uses may result in serious personal injury and/or property damage.

The following restrictions and prohibitions must be strictly adhered to:

- Treadmill may not be used without prior instruction by qualified personnel.
- Children may not use the device or be left near the device unattended.
- Animals and children may not use the device or be left near the device unattended.
- Use of the treadmill under the influence of alcohol, drugs and/or narcotics is prohibited.
- The treadmill is not intended to be used by people weighing more than 800 lbs. (360 kg) when walking at speeds up to 4 mph, or more than 400 lbs. (180 kg) when running at speeds exceeding 4 mph.
- Transportation of objects on the treadmill is not allowed.
- Walking surface is not suited for the use of running shoes with spikes or studs.
- It is forbidden to use the treadmill without its side rails or with walking poles.
- The operation of WOODWAY slat belt treadmills outside of the named ambient conditions in the section "Setup & Installation" (temperature, humidity, air pressure) as well as outdoors (i.e. outside of closed rooms) is not allowed.
- For people with health limitations or contraindications, the use of a treadmill without prior consultation by a health care professional is prohibited.
- When stepping onto the treadmill, during walking exercises, and when stepping off the treadmill the safety instructions in this manual must be observed. Here, the following restrictions apply:
 - Never jump onto the moving belt
 - Never jump off while the device is moving

- Never stop walking when the belt is moving
- Never turn around when the belt is moving
- Never walk sideways or backwards
- Never set the stress level (speed) too high

 **WARNING**

04

Unauthorized Use Can Cause Injury!

Using the treadmill in a manner not authorized by WOODWAY can be potentially hazardous.

- Only use the device for its intended use as described in the manual.
- Do not use unauthorized replacement parts or accessories that could interfere with the functionality or safety of the device.
- Always use the safety handrail when mounting and dismounting and when starting training.
- If the device is damaged or not functioning properly, do not use until it has been inspected and/or repaired by qualified and authorized personnel.

2 Introduction

2.1 Operating Instructions Information

This manual provides information on the safe operation of the WOODWAY slat belt treadmill. A condition for safe operation is compliance with all safety and operating instructions.

 CAUTION Y1	
Improper Operation Can Cause Accidents!	
<ul style="list-style-type: none">• Not using the treadmill as intended according to the manufacturer's instructions can cause accidents and equipment damage.• These operating instructions must be completely read and understood before using the treadmill.• Keep these instructions close at hand for all users of the device.	

Read and Observe the Operating Instructions!



Read these instructions carefully before beginning any work on the treadmill. It is a part of the device and must be kept accessible at all times and in the immediate vicinity of the treadmill for operating and maintenance personnel.

Observe the Instructions

WOODWAY accepts no liability for accidents, equipment damage, and consequences of equipment failure that are a result of failure to follow the operating instructions. In addition, local accident prevention regulations and general safety conditions for intended use of the treadmill apply.

The manufacturer reserves the right to make technical changes in the context of improving the performance properties and further development without prior notice.

Illustrations are for basic understanding and may differ from the actual design of the device.

Accessories from other suppliers have further safety regulations and guidelines which must also be observed.

WOODWAY accepts no liability for accidents, equipment damage, and personal injury caused by the use of accessories from other suppliers.

2.2 Limitation of Liability

All information and instructions in this manual have been compiled in accordance with applicable standards and regulations, the current state of technology, and our knowledge and experience.

WOODWAY accepts no responsibility for damages resulting from:

- Disregarding the operating instructions
- Improper use
- Use by non-authorized persons
- Use of replacement parts which were not approved by WOODWAY
- Unauthorized modifications to the device or accessories

WOODWAY general terms and conditions and delivery conditions apply, as well as the legal regulations valid at the time of contract conclusion.

2.3 Copyright

The release of the operating instructions to third parties without the written permission of WOODWAY is prohibited. Duplication in any manner and form - including excerpts - as well as use and/or communication of the content are not permitted without written permission from WOODWAY.

NOTICE

BN7

All contents, text, drawings, images, or other illustrations are copyright protected and are subject to intellectual property rights. Any misuse is punishable by law.

2.4 Replacement Parts

WOODWAY recommends the use of original replacement parts. Original WOODWAY replacement parts have time-tested/documented quality standards that ensure safe reliable operation.

- Developed for specific use with the device
- Manufactured for high quality and excellence
- Ensure the legal warranty period (excluding wear parts) or other reached agreements

NOTICE

BN1

The use of NON-original replacement parts may change the characteristics of the device and interfere with the safe use!
WOODWAY does not accept liability for damages resulting from this.

Disposal: Wear parts are considered hazardous waste! After being replaced, wear parts must be disposed of according to country-specific waste laws.

For further information on disposal, [Disposal page 105](#).

2.5 Customer Service:

Manufacturer:

WOODWAY USA, Inc.
W229 N591 Foster Ct.
Waukesha, WI 53186
USA
Tel.: 1-262-548-6235
Fax.: 1-262-522-6235
E-mail: service@WOODWAY.com
Web www.WOODWAY.com

European Representative:

WOODWAY GmbH
Steinackerstr. 20
79576 Weil am Rhein
Germany
Tel.: + 49 (0) 7621-940 999-0
Fax.: + 49 (0) 7621-940 999-40
E-mail: info@WOODWAY.de
Web www.WOODWAY.de

Customer Service:

Tel.: +49 (0) 7621 - 940 999 - 14
E-Mail: service@woodway.de

For faster processing of your request please have the following data and information available:

- Information on the name plate (specific model/serial number)
- An accurate description of the circumstances
- Customer number (if available)
- What action has already been taken

Servicing: The address of your local service center can be obtained from the manufacturer. After repair or re-installation, the actions listed under "Setup and Placement" ([see Chapter 6, Page 30](#)) are to be performed as during installation.

2.6 UL Certification



Underwriters Laboratories (UL LLC) Safety Certification Report

Model:	4Front Med, Pro Med, Pro XL Med
Device Description:	Medical Treadmill
Applicant:	Woodway USA, Inc W229 N591 Foster Ct. Waukesha, WI 53186 USA
Manufacturer:	Same as Applicant
Manufacturing Facility(ies):	Woodway USA, Inc W234 N700 Busse Rd. Waukesha, WI 531186 USA
Report No.:	E473004-D1001-1/A0/C0-UL
Report (Re)Issue Date:	2018-02-02
Base Standard(s):	ANSI/AAMI ES60601-1:2005/(R)2012 and A1:2012, C1:2009/(R)2012 and A2:2010/(R)2012, CAN/CSA C22.2 No. 60601-1:14
Additional Standards:	
Report Types:	This report consists of the following report types: [Yes] US Certification (UL Classification) [Yes] CAN Certification (cUL Classification)

This report covers the Safety evaluation of the referenced model(s) according to the standard(s) specified above.

3 Dimensions and Technical Specifications

3.1 Product Line Overview

WOODWAY 4 Front Medical Treadmills offer enhanced safety protocols and specific build options tailored to suit all levels of professional physical rehabilitation therapists and professional medical rehabilitation environments.

Based on WOODWAY's proven 4 Front treadmill platform, 4 Front Medical treadmills incorporate added safety features, and optional gas assist adjustable handrail configurations to best suit the intended use.

This manual covers models with "Standard" Handrail rail configurations incorporating Quickset and Personal Trainer Control Consoles, as well as optionally equipped models incorporating Medical Grade Adjustable Handrail Gantries utilizing the Personal Trainer Control Console.

3.2 RS-232 Interface

With this option you can switch between the treadmill display and a remote computer for the purpose of remote control. The receptive programs are available. Ask your salesperson for details.

- a. The treadmill's RS-232 interface may only be used for approved medical devices!
- b. When using the RS-232 interface, the requirements for ME systems must be considered.

3.3 Name Plates:



Each WOODWAY treadmill receives a serial number during production. Depending on the year of your model, it has an alphanumeric code with 7-8 characters or a numeric code with 9 digits.

The serial number can be found on the name plate, which is mounted on the rear of the display or on the left front of the treadmill frame. The name plate contains the device's main technical details. The treadmill range of functions is stated on the name plate and on the delivery note.

If this manual has been printed, write the Serial Number, Model Number and Model Code in the spaces below, as they will be needed when contacting the WOODWAY service department.

Serial Number: _____

Model Number: _____

Model Code _____

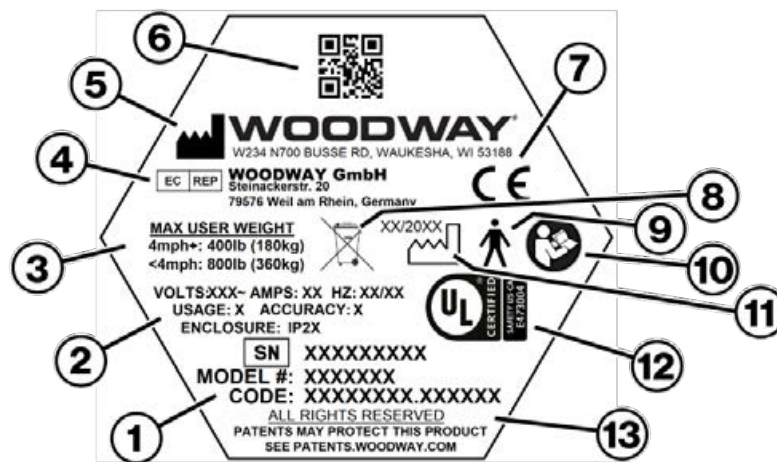

- 1) Serial Number, Model Number, and Model Code Number
- 2) Power Requirements: Voltage, Amperage, and Hz, Accuracy and usage classifications, and enclosure rating (IEC-60529)
- 3) Max User Weight (Speed Specific)
- 4) European Representative
- 5) Manufacturer - WOODWAY logo and address
- 6) 2D Universal Identification Code for Internal Product classification (Scan=D0ZQ77XXXXXXXXXX)
- 7) Device CE Label
- 8) Do Not Discard Warning
- 9) Medical Use Icon
- 10) Note to Read and Observe operating instructions
- 11) Number of notified body if applicable, and year manufactured
- 12) UL Certification
- 13) Patent Notice

Note: Nomenclature label information and symbols may vary from model to model depending on options and configurations.

3.4 Dimensions

3.4.1 4 Front Med Model

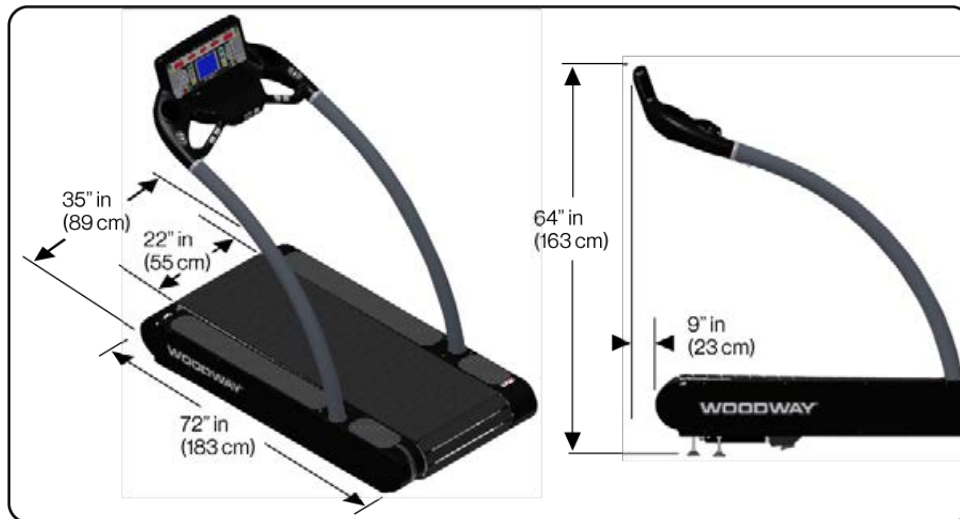

Standard Features:

- Drive System: 2 hp Continuous (5 hp peak) Brush-less Servo motor
- Running Surface / Support System: 114 ball bearings, 12 guide rollers
- Overall Dimensions: 35" W x 73" L x 64" H (89 x 185 x 163 cm)
- Weight: 445 lbs. (201 kg)
- Speed: 0-12.5 mph (0-20 km/h)
- Incline: 0-15%
- Quick Set - LED screen displays the parameters speed, incline, distance, time, heart rate, calories burned, pace
- Power Supply:
 - 115 VAC 20 Amp (NEMA 5-20R outlet, 20 Amp dedicated circuit required)
 - 208/230 VAC 20 Amp (NEMA 6-20R outlet, 20 Amp dedicated circuit required)

Options:

- Higher Speeds: up to 18 mph (29 km/h)
- Reverse: 0-5 mph (0-8 km/h) (Reverse option U.S. Only)
- Steeper Incline: up to 25%
- Incline: (-3%)-(+22%)
- Quick Set Display Console
- LCD Personal Trainer Display Console
- Interface RS232 including control software
- Special paint finish

Additional options may be available. Please contact your sales representative.

3.4.2 4 Front Pro Med Model



Standard Features:

- Drive System: 2 hp Continuous (5 hp peak) Brush-less Servo motor
- Running Surface / Support System: 114 ball bearings, 12 guide rollers
- Overall Dimensions: 48" W x 73" L x 68" H (122 x 185 x 173 cm)
- Weight: 575 lbs. (261 kg)
- Speed: 0-15 mph (0-24 km/h)
- Incline: 0-25%
- Quick Set - LED screen displays the parameters speed, incline, distance, time, heart rate, calories burned, pace
- Power Supply:
208/230 VAC 20 Amp (NEMA 6-20R outlet, 20 Amp dedicated circuit required)

Options:

- Higher Speeds: up to 16.5 mph (26 km/h)
- Reverse: 0-5 mph (0-8 km/h) (Reverse option U.S. Only)
- Steeper Incline: up to 25%
- Incline: (-3%)-(+22%)
- Quick Set Display Console
- LCD Personal Trainer Display Console
- Interface RS232 including control software
- Jump Plate
- Special paint finish

Additional options may be available. Please contact your sales representative.

3.4.3 4 Front Pro XL Med Model

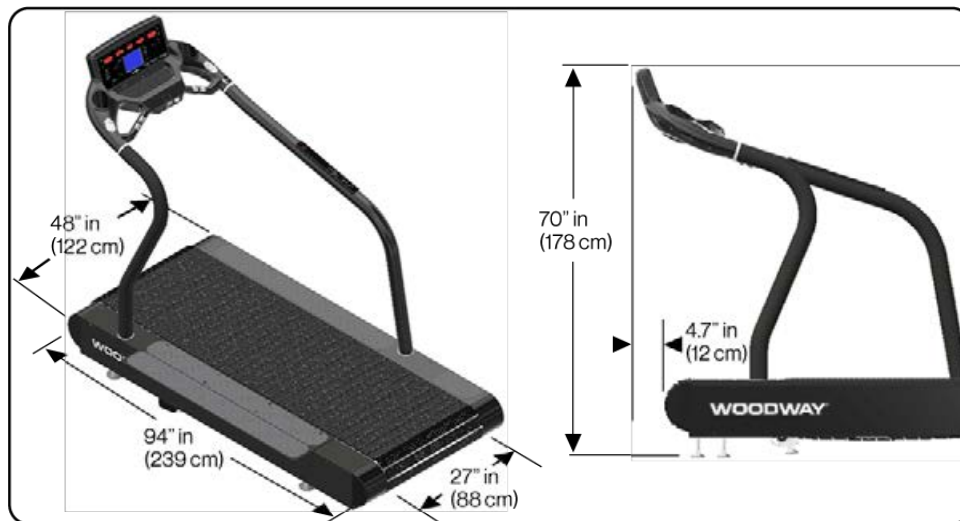
**Standard Features:**

- Drive System: 2 hp Continuous (5 hp peak) Brush-less Servo motor
- Running Surface / Support System: 160 ball bearings, 18 guide rollers
- Overall Dimensions: 48" W x 93" L x 70" H (122 x 236 x 178 cm)
- Weight: 675 lbs. (307 kg)
- Speed: 0-15 mph (0-24 km/h)
- Incline: 0-25%
- Quick Set - LED screen displays the parameters speed, incline, distance, time, heart rate, calories burned, pace, and MET's
- Power Supply:
208/230 VAC 20 Amp (NEMA 6-20R outlet, 20 Amp dedicated circuit required)

Options:

- Higher Speeds: up to 16.5 mph (26 km/h)
- Reverse: 0-5 mph (0-8 km/h) (Reverse option U.S. Only)
- Steeper Incline: up to 25%
- Incline: (-3%)-(+22%)
- Quick Set Display Console
- LCD Personal Trainer Display Console
- Interface RS232 including control software
- Jump Plate
- Dual Handrail
- Special paint finish

Additional options may be available. Please contact your sales representative.

3.4.4 4 Front Med Gas Assist Parallel Handrail (GAPH)

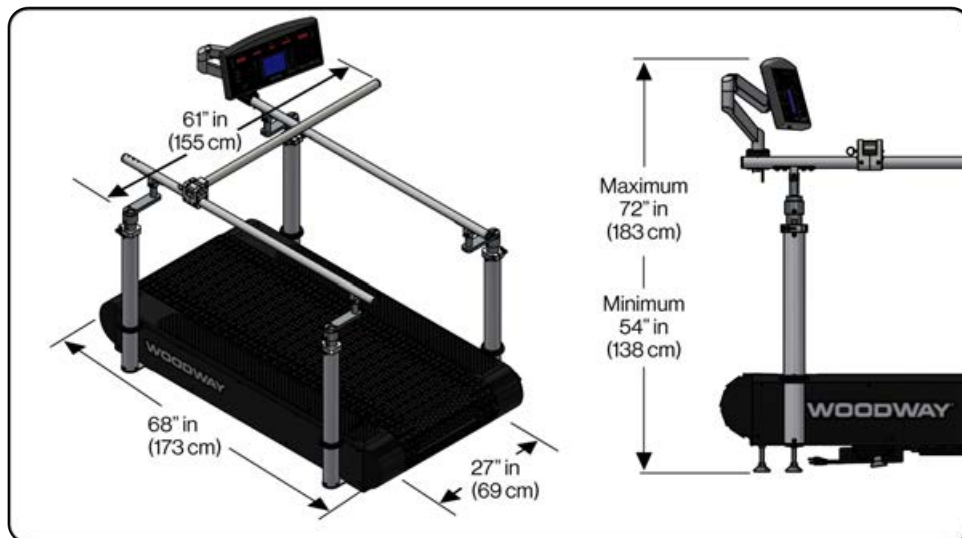

Standard Features:

- Drive System: 2 hp Continuous (5 hp peak) Brush-less Servo motor
- Running Surface / Support System: 114 ball bearings, 12 guide rollers
- Overall Dimensions: 35" W x 72" L x 64" H (89 x 183 x 163 cm)
- Weight: 445 lbs. (201 kg)
- Speed: 0-12.5 mph (0-20 km/h)
- Incline: 0-15%
- Personal Trainer LCD or Quickset screen mounted on adjustable swing arm support
- Fully adjustable Gas Assist Parallel Handrail
- Movable handrail Controls and Emergency Stop Button
- Power Supply:
115 VAC 20 Amp (NEMA 5-20R outlet, 20 Amp dedicated circuit required)
208/230 VAC 20 Amp (NEMA 6-20R outlet, 20 Amp dedicated circuit required)

Options:

- Higher Speeds: up to 18 mph (29 km/h)
- Reverse: 0-5 mph (0-8 km/h) (Reverse option U.S. Only)
- Steeper Incline: up to 25%
- Incline: (-3%)-(+22%)
- Interface RS232 including control software
- Special paint finish

Additional options may be available. Please contact your sales representative.

3.5 Conditions for Use

Description	Parameters
Ambient Temperature	50°F to 104° (10°C to 40°C)
Relative Humidity	20-95% (not condensed)
Enclosure Rating	IP2x

3.7 Electrical Connections

IMPORTANT - The power cord must be properly protected at all times, both when in use and storage.

DO NOT BEND OR REMOVE PRONGS. The plugs are polarized, meaning the prongs are different sizes and the plug can only fit in the outlet one way; If other power cord plugs are required, please contact WOODWAY.

Before connecting the treadmill to the power supply, the information on main voltage and frequency (found on the name plate) is to be compared with the on-site connection values.

Only connect the device if the values match. Power surges or voltage drops can cause malfunctions or defects in the device.

No other treadmills or devices may be operated on the same supply line. Each treadmill must be operated with its own circuit breaker.

The treadmill must be grounded.

!
DANGER
R4

Danger of Death by Electric Shock!

Improper handling of electrical equipment by unqualified persons can cause fatal electrical shock.

- If necessary, allow only qualified personnel to perform electrical installation.
- The power cord must not come into contact with hot surfaces or sharp edges.
- Electrical parts (i.e. motor, power cord, and power switch) must not come in contact with water.

Below are the standard electrical requirements by region. There are different options depending on which model you own. If you have a different electrical configuration, please contact your sales representative.

3.7.1 North America

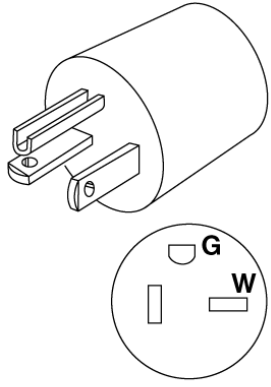
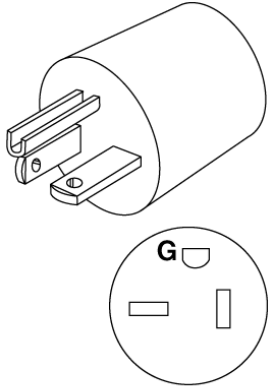
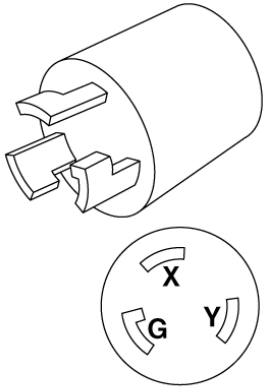
Description	Parameters		
	115 VAC	208/230 VAC	208/230 VAC
Voltage	Requires at least 115 V from wall outlet. If voltage falls 10% below 115 V, treadmill will shut off and reset.	Requires at least 208/230 V from wall outlet. If voltage falls 10% below 208/230 V, treadmill will shut off and reset.	Requires at least 208/230 V from wall outlet. If voltage falls 10% below 208/230 V, treadmill will shut off and reset.
Frequency	50/60 Hz	50/60 Hz	50/60 Hz
Current	20 Amp <i>Dedicated line required (cannot share neutral line)</i>	20 Amp <i>Dedicated line required (cannot share neutral line)</i>	30 Amp <i>Dedicated line required (cannot share neutral line)</i>
Wall Outlet Requirements	 <p style="text-align: center;">NEMA 5-20</p>	 <p style="text-align: center;">NEMA 6-20</p>	 <p style="text-align: center;">NEMA L6-30</p>
Outlet Compatibility	Standard 3-prong, hospital grade plug (NEMA 5-20 P) Will ONLY fit a NEMA 5-20 R outlet	3-Prong plug (NEMA 6-20 P) Will ONLY fit a NEMA 6-20 R outlet	3-Prong Twist plug (NEMA L6-30 P) Will ONLY fit a NEMA L6-30 R outlet
Hospital-Grade Low Leakage	For grounding reliability only connect to proper receptacle marked "Hospital Grade" when using for Medical use.		

3.7.2 Europe

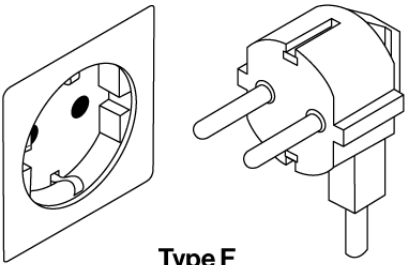
Description	Parameters
	208/230 VAC
Voltage	Requires at least 208/230 V from wall outlet. If voltage falls 10% below 208/230 V, treadmill will shut off and reset.
Frequency	50 Hz
Current	16 Amp <i>Dedicated line required (cannot share neutral line)</i>
Wall Outlet Requirements Germany, Australia, the Netherlands, Sweden, Norway, Finland, Portugal, Spain, and Eastern Europe. Two Round Prong Holes, and Two Ground Clips / Two Round Prongs and Two Ground Clips.	 <p style="text-align: center;">Type F</p>

3.7.3 United Kingdom

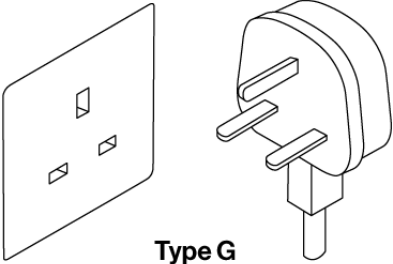
Description	Parameters
	208/230 VAC
Voltage	Requires at least 208/230 V from wall outlet. If voltage falls 10% below 208/230 V, treadmill will shut off and reset.
Frequency	50 Hz
Current	13 Amp <i>Dedicated line required (cannot share neutral line)</i>
Wall Outlet Requirements Outlet Compatibility G/BS 1363 plug	 <p style="text-align: center;">Type G</p>

3.7.4 Toroidal Power Transformer

4 Front Medical Treadmills (Personal Trainer, Quickset, and Gas Assist Handrail Models) utilize a Hospital Grade Toroidal Power Transformer, providing Low Leakage Current, which is an important safety protocol for medical clinics, physical therapy facilities, and hospitals.

A **Toroidal Power Transformer (1)** located at the front Right corner of the chassis can reduce current leakage to less than 200 micro-amps (uA).

The transformer is used to provide 115 VAC for internal electrical components in 208/230 VAC input models.

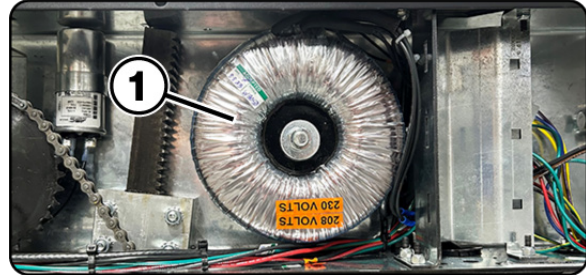

It may also be connected as an isolation transformer for treadmills that have the isolation option installed.

In this case the transformer will have a 115 VAC input with an internally isolated 115 VAC output. (the transformer is an option and may not be found on every 4 Front model).

3.7.5 Grounding Information

The treadmill must be grounded.

If it should malfunction or breakdown, grounding provides a path of least resistance for electrical current to reduce the risk of electrical shock.

This product is equipped with a cord having an equipment-grounding conductor and a grounding plug.

The plug must be plugged into an appropriate outlet that is properly installed and grounded in accordance with all local codes and ordinances.

! DANGER

To Reduce the Risk of Electric Shock!

Improper connection of the equipment-grounding conductor can result in a risk of electrical shock..

- Check with a qualified electrician or serviceman if you are in doubt as to whether the product is properly grounded.
- Do not modify the plug provided with the product.
- If it will not fit the outlet, have a proper outlet installed by a qualified electrician.

Refer to: [Chapter 3.7 Electrical Connections](#) for plug types and ratings.

3.7.6 Grounded Outlet Information

For a grounded, cord-connected product rated less than 15 A and intended for use on a nominal 120-V supply circuit, the follow instructions in either (1) or (2):

1) This product is for use on a nominal 120-V circuit, and has a grounding plug that looks like the plug illustrated in **Sketch A**.

A temporary adapter that looks like the adapter illustrated in **Sketch B** may be used to connect this plug to a 2-pole receptacle as shown in **Sketch B** if a properly grounded outlet is not available.

The temporary adapter should be used only until a properly grounded outlet (**Sketch A**) can be installed by a qualified electrician.

The Green colored rigid Tab, Lug, or the like extending from the adapter must be connected to a permanent ground such as a properly grounded outlet box cover.

Whenever the adapter is used, it must be held in place by a Metal Screw.

2) This product is for use on a nominal 120-V circuit and has a grounding plug that looks like the plug illustrated in **Sketch A**.

Make sure that the product is connected to an outlet having the same configuration as the plug.

No adapter should be used with this product.

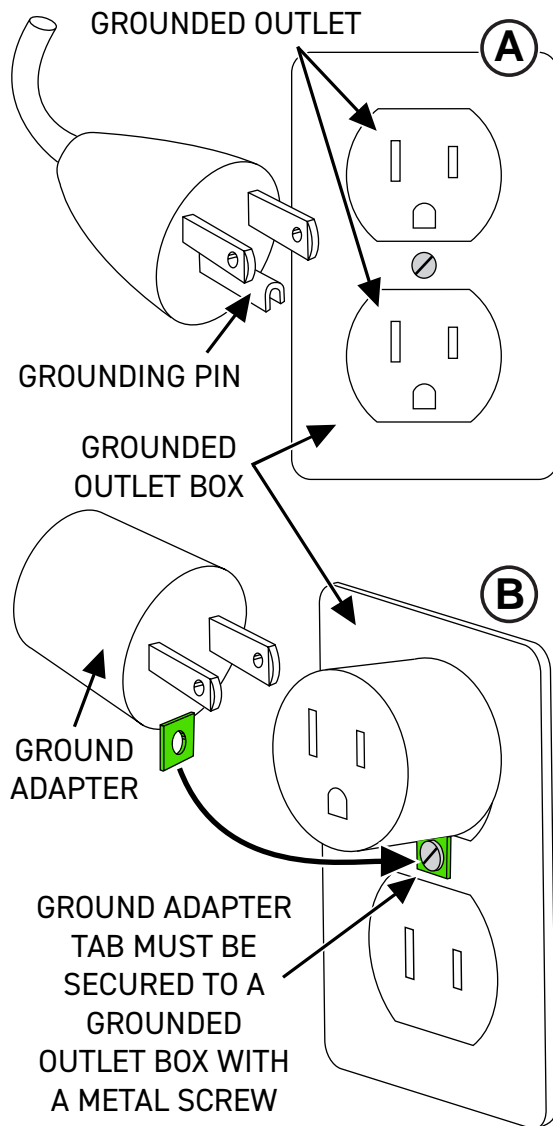

4 Transportation and Storage

4.1 Safety Notices for Transportation

Check the treadmill for damage upon arrival. Also check and compare supplied accessories with the corresponding delivery note.

The manufacturer is not liable for damages and missing parts if this information was not recorded in writing on the delivery note upon delivery of the unit.

Damage or defects must be reported to the carrier and to the responsible WOODWAY dealer immediately.

 WARNING 05	
<p>Risk of Injury by machine Falling or Falling Over!</p> <p>Improper transportation of the device may lead to it falling over and causing injury or equipment damage.</p> <ul style="list-style-type: none"> • Only transport in compliance with the safety regulations. • Only use the supplied carrying tubes for transport. • Never lift the device using the railing or protective coverings. • Ensure stable center of gravity and steadiness during transportation. 	

WOODWAY Service If necessary, transport or relocation can be organized and carried out by authorized WOODWAY service partners.

For further information please contact WOODWAY Customer Service.

4.2 Flat Transportation

The equipment can be transported on a flat surface using a commercial grade transport dolly that is 30"x18".

Make sure the dolly is between the **Rear Feet (1)** and the **Incline Feet (2)** of the treadmill.

Make sure the frame of the treadmill is resting on the Cart and NOT on the Running Belt.

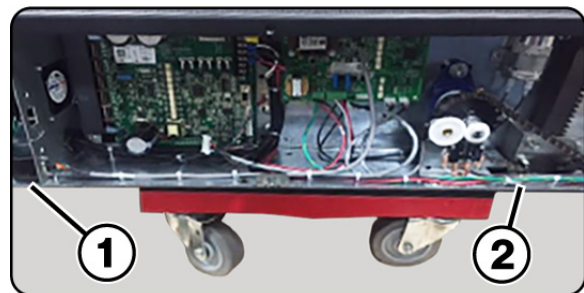

4.3 Upright Transportation

For narrow transport routes it is possible to transport the treadmill vertically (e.g. narrow door width or for climbing stairs).

For this, handrails and side panels must be removed.

When transporting in an upright position, the device must be additionally secured against accidental tipping or rolling since the center of gravity is not in the middle of the device.

4.4 Transportation with Carrying Poles

Four lift bars (round steel tubes) are included as treadmill accessories.

The lift bars can be inserted into the **Front and Back Ports (1)** located at each end of the treadmill frame.

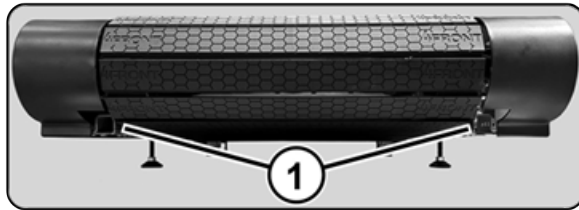

The side panels and railings can be removed to facilitate transport.

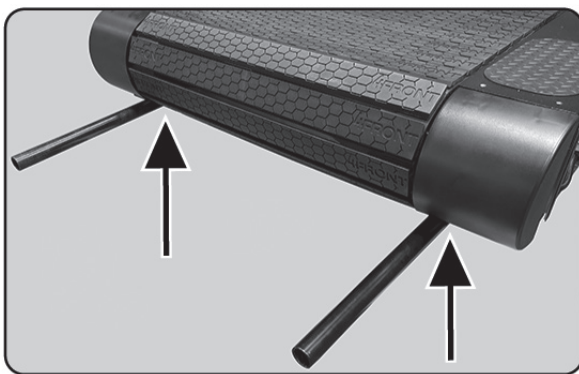

4.5 Storage

The device may only be stored in closed, dry rooms. It is necessary to prevent contact with moisture (rain, fog, etc.).

The following environmental conditions are prescribed for transportation and storage:

- Temperature: 0°F to 120°F (-18°C to +49°C)
- Relative humidity: 20-95% (not condensed)
- Air pressure: 700-1060 hPa

5 Product Description / Overview

5.1 Running Surface

The running surface belt consists of individual rubber on aluminum slats which are mounted on a set of wedged-toothed belts.

The individual slats consist of two components.

The base is a solid aluminum profile and the tread is comprised of a high-traction rubber compound (Approx 40 Shore A). The combination makes it “the softest treadmill in the world”.

The approx. ½” (1.2 cm) thick rubber surface significantly reduces the impact energy, thus making WOODWAY treadmills much easier on the joints than conventional treadmills.

The WOODWAY running surface differs fundamentally from running belts on conventional treadmills (for which cotton-nylon belts are normally used).

On WOODWAY treadmills users may initially notice a higher surface grip than experienced on other treadmills.

With repeated use, the user will become accustomed to the grip.

As with all treadmills, it is important that the user not to shuffle their feet if possible.

 WARNING 011	
<p>Risk of Injury Through Risk of Falling!</p> <p>During training, especially during the initial use of the device there is a danger of injury from falling.</p> <ul style="list-style-type: none">• Familiarize yourself with treadmill operation before training.• Hold on to the safety handrail during the first training program until you can move safely on the treadmill.	

5.2 Transport System

The support system consists of 2 supporting/secondary rails, which are equipped with high performance bearings.

6 V-belt guides on each rail ensure lateral stability. The rollers transfer the load to and from the motor and prevent the running belt from slipping through.

The system supports the running surface and distributes the load evenly over the entire treadmill.

The running surface belt (slats and steel-wire reinforced, toothed V-belt) is guided by form-fitted drive pulleys on the front and back.

The device can even be used without external drive, simply by pushing the treadmill to start the belt moving.

The combination of running surface, secondary bearing rails, and drive pulleys gives this slat system unique characteristics:

- Low friction (energy saving)
- Low wear (approx. 150,000 mile [240,000 km] functional service life)
- 100% power transfer through the form-fitted, toothed V-belt system
- High service life (one running surface belt for one treadmill life)

5.3 Incline System

WOODWAY treadmills are equipped with a standard incline system which is model specific. The incline system is driven by a geared motor and a chain drive system which is used to transmit forces to several drive sprockets.

This gear drive raises or lowers the treadmill on toothed racks.

The toothed racks are equipped with rubber feet and bear most of the weight of the treadmill and user when the incline is engaged.

Limit switches are used to control the Up and Down limits of the lifting system.

When the display is switched on, the running surface is automatically moved to the 0 incline position (starting position).

 WARNING 012	
<p>Danger of Device Moving Down when Switched on!</p> <p>If the treadmill was in the inclined position prior to being switched off during previous use, the device will automatically move back to the neutral position (0% incline). There is a danger of injury!</p> <ul style="list-style-type: none">• No one may be located in the area in front of the treadmill.• No objects may be located under the treadmill.• Check the position of the treadmill before switching it on.	

5.4 Dynamic Mode (Overview)

013
WARNING

Do Not Leave Treadmill Unattended While in Dynamic Mode!

If the treadmill is left unattended while in dynamic mode, there is a possibility of personal injury from people stepping onto device while assuming the running surface is locked.

- Never leave treadmill unattended while in dynamic mode.
- The running surface runs completely free in both directions and is no longer slowed by the motor.
- Always keep children and animals clear of the treadmill while in dynamic mode.

The treadmill makes it possible that the user serves as the running surface belt drive. The user drives the running surface belt manually during training. This is known as “Dynamic Mode”

5.5 Power/Main Fuse Console - Turning Treadmill ON/OFF

Located on the lower front right corner of the units chassis is the **Main Fuse (1)** and **Main Power ON/OFF Switch (2)**



5.6 Safety Equipment

The WOODWAY treadmills are equipped with different safety equipment depending on model and design.

When needed, they serve to prevent dangerous situations and reduce the risk of injury to a minimum. The following safety equipment is available:

- Emergency stop pull-cord with magnetic switch on the display
- PAUSE and STOP buttons on display (and handrail on some models)
- Non-slip coating on side panels (allows emergency dismount by straddling)

5.6.1 Safety Handrail

Standard Handrail Models are equipped with a fixed handrail that extends along both sides. This allows the user to maintain direct contact, to obtain safety and stability during training. Medical Handrail Option employs an adjustable Handrail Gantry System that has fully adjustable right and left handrails and adjustable control console support stand. For safety reasons, the user should hold on to the handrail when necessary (e.g. for stopping).

 CAUTION Y5
<p>Risk of Injury Through Risk of Falling!</p> <p>It is recommended to use the Handrail for mounting and dismounting.</p>

5.6.2 Emergency Stop Pull-Cord

The Emergency Stop switch is a magnetic contact switch, which is attached in the running direction on the display head. The circuit is closed through the use of a magnet. When the Magnet is removed from the Contact Surface, an interruption of the power supply will initiate an Emergency Stop.

The magnet is secured to the runner's clothing by a clip on a lanyard/pull-cord. It should be fixed to a tight piece of clothing (e.g. waistband). The Safety Magnet can also be used to immobilize the treadmill and prevent a third party from using the device.

To prevent the use of the treadmill, for example when not supervised, the safety magnet with pull-cord can be stored in a safe place and the treadmill cannot be put into operation. The pull-cord is not fall protection and cannot prevent a person from falling on the treadmill. It only serves as an Emergency Stop in dangerous situations.

When the magnet is released, the drive system disconnects from the power and an Emergency Stop is initiated. There is an increased risk of falling (e.g. during performance diagnostics, intense sprinting, and long runs). There is an increased risk of injury from falling, especially in rehabilitation where patients with various physical limitations use the treadmill.

 WARNING 014
<p>Danger of Injury due to Improperly Installed Pull-Cord!</p> <p>If the pull-cord is not installed properly before a workout, the Emergency Stop magnetic switch will not be triggered and there is a risk of injury in the event of a dangerous situation.</p> <ul style="list-style-type: none"> • The use of the pull-cord is MANDATORY. • Securely attach clip to tight clothing before starting the workout. • Adjust the length of the pull-cord with rope stopper to the shortest possible setting, while ensuring that movement is still unrestricted.

5.6.3 Belt Drive Current Limiting

WOODWAY Med Series treadmills are equipped with a current limit control function which reduces power consumption and increases safety. The main safety feature is the current limiter after time overflow.

If the running belt is blocked for more than 10 seconds, the motor current will be reduced to 6A. This is always recommended in case something gets caught in the belt, as it stops the belt automatically.

Once the current limit control has been triggered, the motor torque is reduced to a minimum to prevent damage to the motor and electric system.

5.6.4 Low Leakage Current

The requirement for low leakage current is important for medical clinics, physical therapy facilities, and hospitals.

The treadmill functions are designed so that the power plug and input power transformer are subjected to low leakage current. With an input power transformer with low leakage current, the leakage treadmill current can be reduced to less than 200 micro-amps (uA).

5.6.5 Dismounting in Emergency Situations

WOODWAY treadmills have a slip-resistant surface alongside the running surface.

This offers an additional grip when dismounting and prevents the users feet from slipping off the side panels.

The slip-resistant surface should be checked periodically for wear or lack of grip and replaced if necessary.

In emergencies, dismount the treadmill as follows:

- Jump onto and straddle the side panels.
- The running surface can run between the legs.
- Then stop the treadmill using the normal STOP Button or the Emergency Stop Button.

An alternative is to stand on the side panel with both feet on one side of the running surface, right or left and to hold on to the handrail.

The STOP button or Emergency Stop Button may then be used to bring the running belt to a stop.

! WARNING

015

Danger of Injury by Falling when Switching the Device Off!

A complete shutdown of the unit caused by power surges or voltage dips can cause abrupt deceleration of the running surface belt.

- To avoid malfunctions, all data on the name plate must correspond with the actual terminal values.

! WARNING

016

Dangerous Situations During Operation Can Cause Injury!

Conditions during use of the device that do not correspond to the normal function and require an immediate stop can cause injury. Each actuation of the Emergency Stop switch causes a power disconnection to the drive system which in turn causes the running surface to emergency stop, which presents an additional risk of falling.

- Immediate Emergency Stopping of the device/drive.
- Switching off the device (power button) and pulling the power cord from the socket.
- Clarification and elimination of causes of dangerous situations only be cleared by a certified WOODWAY Customer Service Representative.
- Only restart the device after the approval by a certified WOODWAY Customer Service Representative.

6 Setup and Placement

6.1 General

Ensure that the conditions applicable to basic safety and health requirements are met, and that Chapter 1 "Safety" has been read and understood.

Read owner's manual instructions completely before installation.

Before using the unit, operational and functional safety systems are to be tested, including correct installation and operator instructions.

In most cases, your WOODWAY treadmill will be delivered completely assembled, check immediately upon delivery for any signs of transportation damage and immediately report any damage to the transport company and WOODWAY.

ATTENTION

BA7

Installing after Storage or Transport

The formation of condensation on the cooled electronic parts may cause the treadmill to malfunction and damage to the electronics.

- Before installing after storage or transport, the treadmill must stand at room temperature for approximately 3 hours to become acclimated.

6.2 Preparation and Placement

ATTENTION

Prepare a Stable Surface

Before the device is installed, the surface must be prepared. The total weight of the device (with all the accessories and options) is to be considered.

- Prepare a stable and sturdy surface.
- Only install the device on a level, stable, and sufficiently sturdy surface. If necessary, install an additional base plate/floorboard.

In most cases WOODWAY treadmills are delivered completely assembled, some disassembly/assembly may be required for moving or relocation to other locations.

Due to the heavy weight of the device, it is recommended to install the treadmill as close to its final location as possible.

Carefully dismantle the shipping crate. To do this, remove the screwed connections. Remove protective wrap from all packaged parts.

Ensure that the surfaces are not damaged by sharp objects (knife, etc.).

NOTICE

WOODWAY performance and fitness treadmills use standard (inch) screws, bolts and nuts, with few exceptions. These are not compatible with metric fastening elements!

The following further instructions for installation are to be observed:

- When installed on upper floors, the device must be placed as far as possible in a corner of the room so that sufficient stability is guaranteed. The structure of the building must be checked in advance.
- The treadmill should not be installed close to a radiator or other heat source.
- Due to moving parts on the underside, the device must not be placed directly on thick or high pile carpeting. In this case, a mat should be placed under the device. This will prevent lint from entering the treadmill and at the same time reduce carpet wear.
- WOODWAY has appropriate mats available. For more information, call WOODWAY customer service.
- With larger devices, particular attention must be paid to the ceiling/floor load capacity at the installation site. This must be higher than the total weight (device weight plus the dynamic weight of a running person) and approved by an authorized authority with the treadmill representative.
- Position the treadmill to ensure that the power cord can easily be accessed and disconnected when needed, and that it is not bent or angled such that it could disconnect.

6.3 Safe Fall Area

When using the treadmill, especially fast movements (fast running, etc) increases the risk of falling. For this reason, a safe fall area of at least 40in x 80in (1 x 2 m) must be maintained behind the treadmill.

No obstacles may be located in this safe fall area. Objects (e.g. furniture, plants, training materials, ladders, etc) may not be placed in this area, and sloping ceilings may not extend into the safety area.

WOODWAY treadmills have a reverse option, therefore a safety area must also be provided in front of the treadmill of at least 20in x 40in (0.5 x 1 m)

When installing multiple treadmills ensure the distance between each unit is at least 20in (0.5 m). (Diagram below shows 4 Front standard for reference)

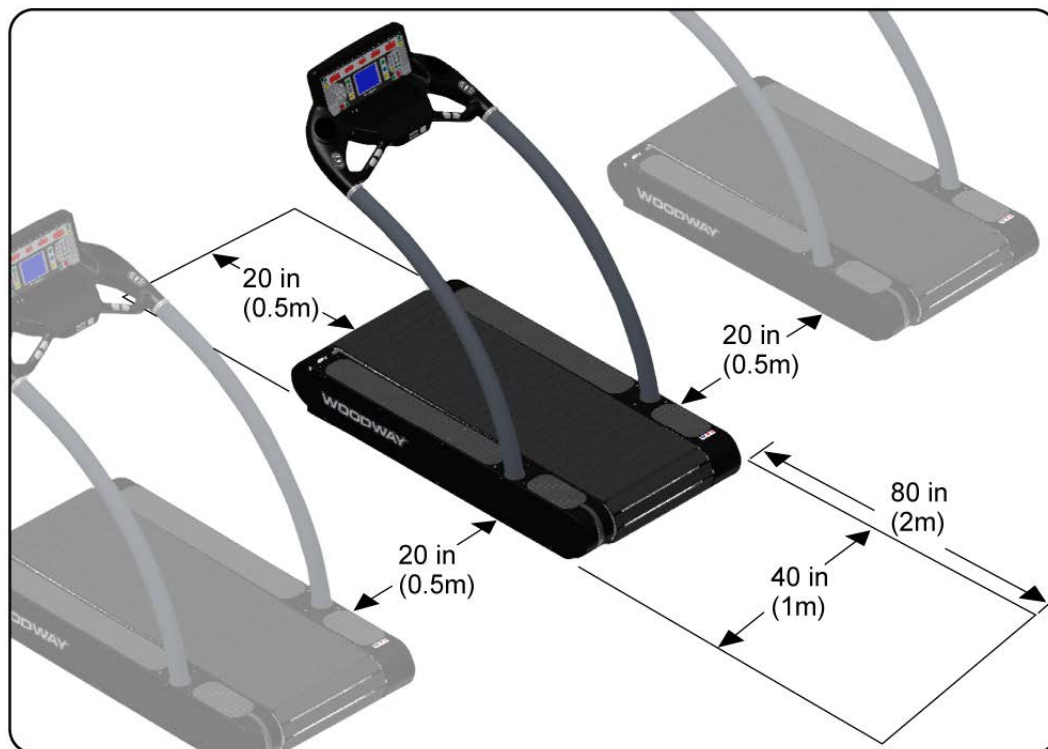

7 Installation Instructions

In some instances, the treadmill may need partial disassembly in order to place/position it in its proper final location, if this is the case refer to [Sub-Chapter 7.2](#)

If the treadmill is able to be uncrated and positioned without any disassembly, it will be necessary to check level and adjust the unit to ensure it is level front to rear (X Axis) and right to left (Z Axis), and that the leveling feet are equally weighted, and the chassis is not twisted or warped after leveling.

7.1 Leveling Instructions

Required Tools:

- #2 Phillips head screwdriver
- 3/4" Combination wrench
- 24" - Bubble level or Digital level

1. To access the leveling feet located at each corner of the unit, both right and left side covers must be removed using a #2 Phillips head screwdriver.



2. With both side covers removed there is access to the **Leveling Feet Lock Nuts (1)** and **Leveling Nuts (2)**. Using a 3/4" wrench loosen the **Lock Nut (1)** and turn it 5 to 6 rotations counterclockwise.

This will give the needed range of movement when adjusting the height using the **Leveling Nut (2)**.

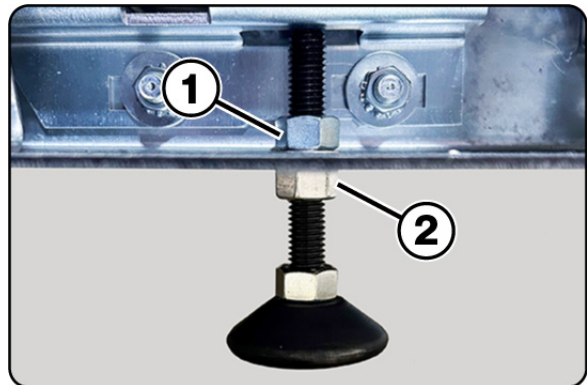

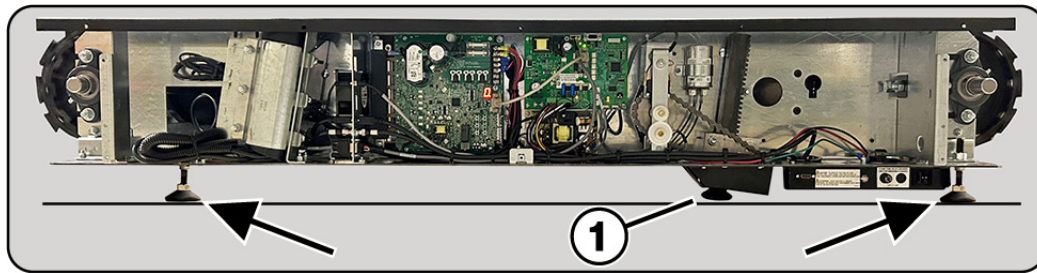

IMPORTANT: When adjusting the 4 corner points it is Very Important to keep the distance of the **Incline Foot (1)** as close to the ground as possible while leveling the overall chassis and chassis height. (incline adjustment feet should be fully retracted when doing this procedure)

The distance of the incline foot should be kept at approximately the thickness of a quarter or 0.069in (1.75mm) gap from the foot to the floor.

- Using a level placed on the chassis top side plate for checking X Axis, and the level placed evenly on one of the running slats to check Z Axis.

Note: When moving the level from X to Z Axis it is important to place the level in the same spot each time to ensure consistent accurate readings.

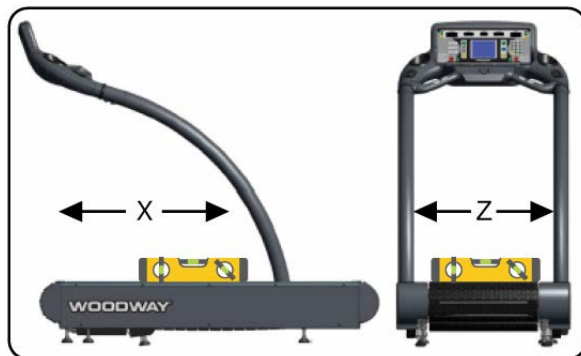

- Using a 3/4" wrench to adjust the **Leveling Nuts (2)** at each corner until both X and Z Axis are level.

Confirm leveling feet are equally weighted by carefully lifting the unit slightly at each corner.

Once confirmed, use a 3/4" wrench to tighten the **Locking Nuts (1)** at each corner.

Reinstall the side covers using a #2 Phillips head screwdriver.

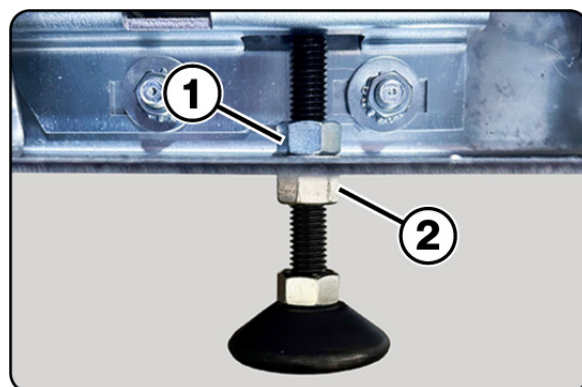

Refer to:

[Sub-Chapter 7.5 Completion of Installation.](#)

Required tools:

- #2 Phillips head screwdriver
- 3/4" Combination wrench
- 24" - Bubble level or Digital level

1. To access the leveling feet located at each corner of the unit, both right and left side covers must be removed using a #2 Phillips head screwdriver.

Remove the nine screws per side securing the side covers.

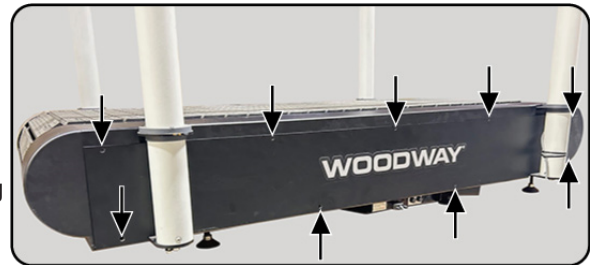

2. With the screws removed pull the bottom edge of the cover away from the chassis and slide the cover towards either the front or rear of the treadmill.

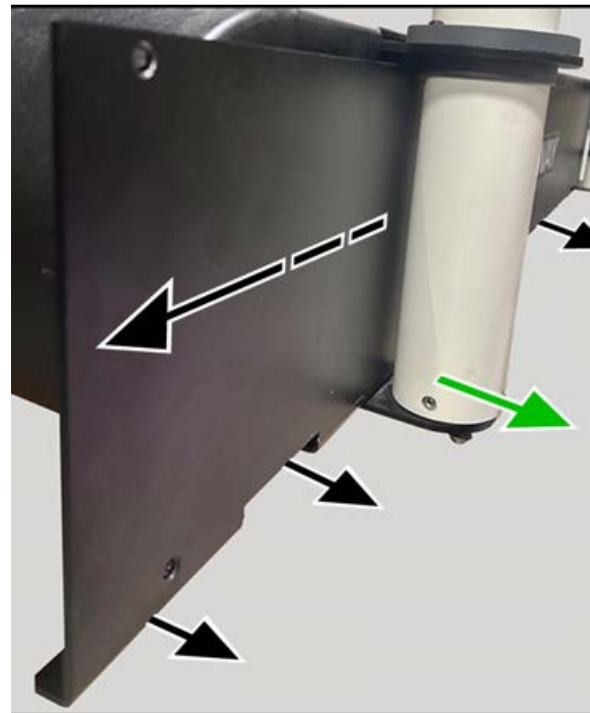

3. In some cases, it may be necessary to loosen the two bolts on the bottom of handrail support and push the support away from the chassis to gain clearance to remove the cover.

Use a 5/32" (4mm) Allen Wrench, and a 9/16" wrench to loosen each bolt a couple turns.

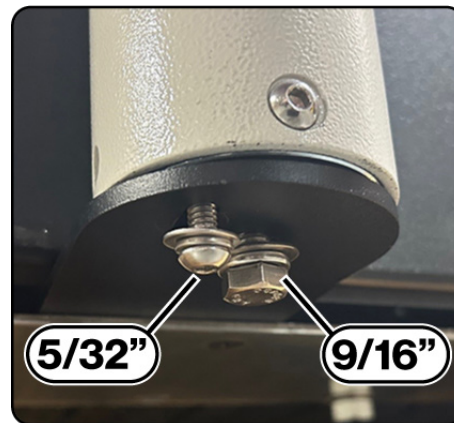

4. With both side covers removed there is access to the **Leveling Feet Lock Nuts (1)** and **Leveling Nuts (2)**. Using a 3/4" wrench loosen the **Lock Nut (1)** and turn it 5 to 6 rotations counterclockwise.

This will give the needed range of movement when adjusting the height using the **Leveling Nut (2)**.

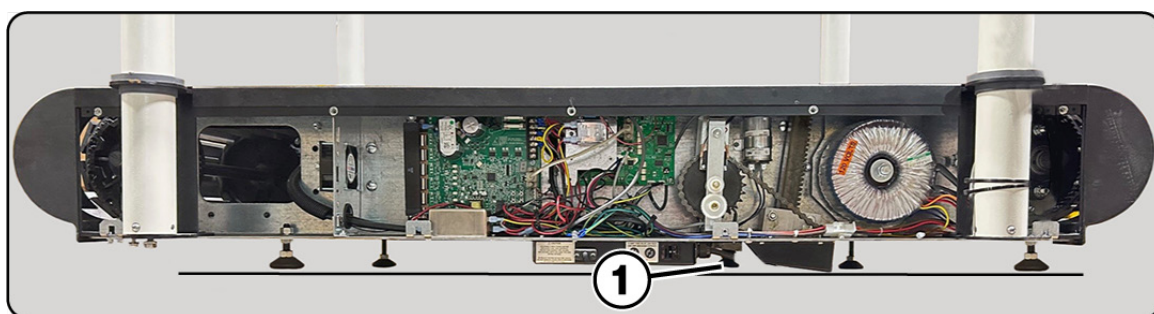
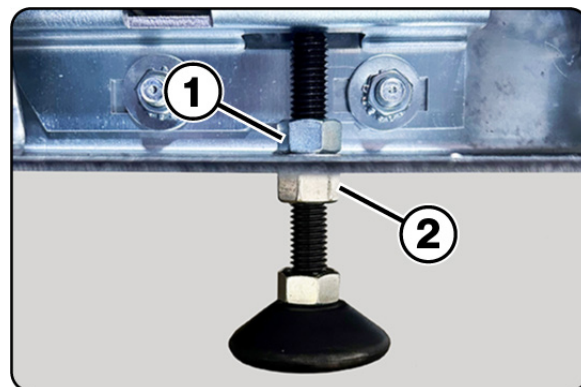

IMPORTANT: When adjusting the 4 corner points it is Very Important to keep the distance of the **Incline Foot (1)** as close to the ground as possible while leveling the overall chassis and chassis height. (incline adjustment feet should be fully retracted when doing this procedure).

The distance of the incline foot should be kept at approximately the thickness of a quarter or 0.069in (1.75mm) gap from the foot to the floor.

- Using a 3/4" wrench adjust the **Leveling Nuts (2)** at each corner until both X and Z Axis are level.

Confirm leveling feet are equally weighted by carefully lifting the unit slightly at each corner.

Once confirmed, use a 3/4" wrench to tighten the **Locking Nuts (1)** at each corner.

Reinstall the side covers using a #2 Phillips head screwdriver.

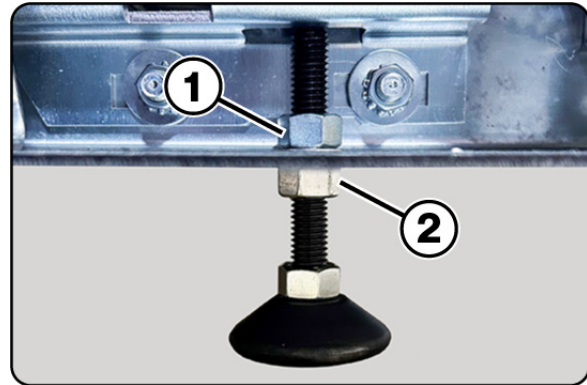

Refer to:

[Sub-Chapter 7.5 Completion of Installation.](#)



- Using a level placed on the chassis top side plate for checking X Axis, and the level placed evenly on one of the running slats to check Z Axis.

Note: When moving the level from X to Z Axis it is important to place the level in the same spot each time to ensure consistent accurate readings.

7.3 4 Front Med Series Dis-Assembly /Assembly

In some instances, it may be necessary to remove the handrail assembly to locate the unit to a different location.

If the unit must be disassembled for moving the following tools will be needed.

Required tools:

- #2 Phillips head screwdriver
- 1/2" Combination wrench or Ratchet wrench
- 3/4" Combination wrench
- Side cutters

(Refer to: [Chapter 4 Transportation and Storage](#) for moving details).

NOTICE	BNS
It is recommended to have a second person assist in removing and inserting the handrail assembly during the following procedures.	

Note: Photos used for disassembly and assembly are the standard 4 Front Med chassis, the Pro Med and Pro XL Med vary slightly regarding handrail location.

Disassembly:

1. Ensure the unit is disconnected from the incoming power supply.

Start by removing both right and left side covers using a #2 Phillips head screwdriver.



2. With the covers removed there is access to the 3 nuts that secure the **Handrail Capture Assemblies (1)** on each side of the unit.

On the right side (electrical panel side) there are **Electrical Connections (2/3)** that must be disconnected prior to removing the handrail assembly.

3. Disconnect the "Spade" **Ground Wire Connection (2)** then disconnect the monitor **VGA Interface Connection (3)** by unscrewing the two retaining screws and gently disconnect it from the port.

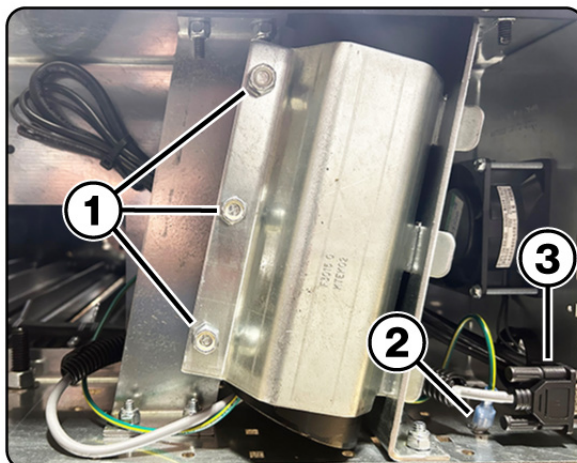

4. Remove any wire ties that may be securing the wire bundle and carefully feed the **Communication and Ground Wire (1)** around the backside of the capture assembly.

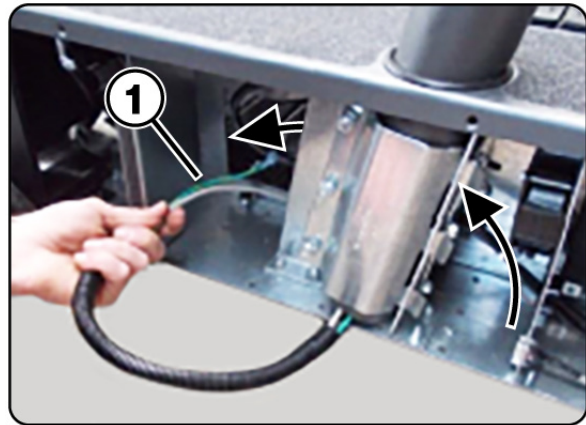

5. Use a 1/2 wrench to loosen the 3 nuts on each of the capture assemblies, loosen the nuts 6 to 8 revolutions each, or enough that the handrail assembly is loose enough to move.

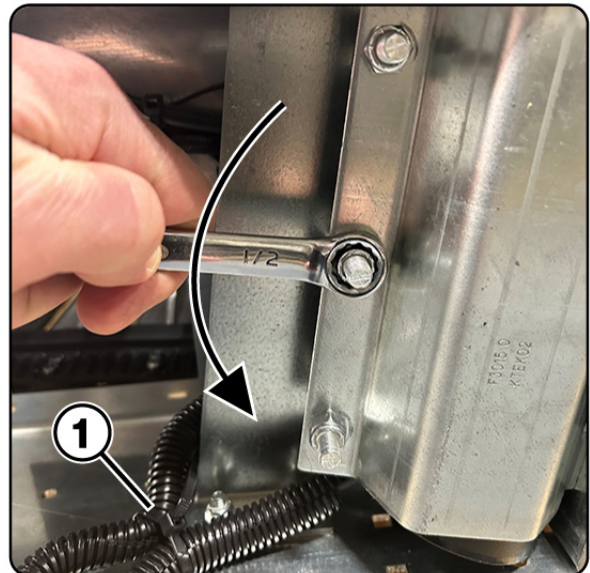

6. With 1 person on each side of the unit carefully lift the handrail assembly up and away from the chassis.

Use caution as Not to catch or snag the communication wires when lifting the handrail assembly.

With the treadmill disassembled in two main components it is now ready to be safely moved to its final location.

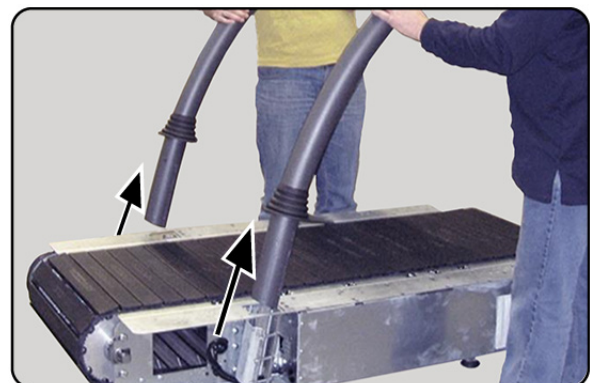

(Refer to: [Chapter 4 Transportation and Storage](#) for moving details).

Re-Assembly:

With the chassis relocated, re-assembly is a reversal of the disassembly process.

1. Carefully coil up the communication wires and tuck them into the end of the handrail with just enough of the ends sticking out to grab later.

Or have someone feed the wires through the capture assembly while the handrail assembly is being inserted into the chassis capture assembly.

Carefully lift the handrail assembly and slide the rail ends into the capture assemblies, using caution not to pinch or catch fingers or wires.

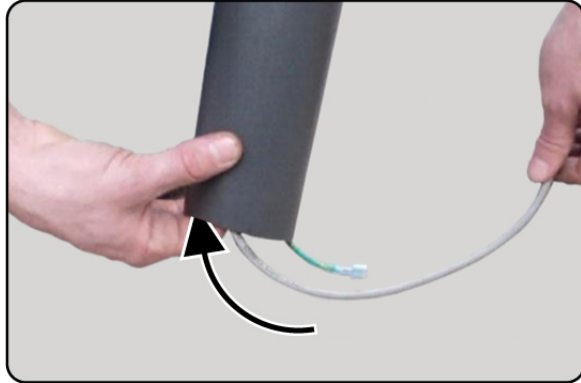

2. With the handrail assembly seated into the capture assembly tighten the 3 Nuts on each of the capture assemblies until tight.

3. Re-route the communication wires back around the capture assembly and reconnect the **Ground Wire (1)** and the **VGA Interface Connection (2)**. Tighten the 2 thumb screws securing it to the communication port.

**Refer to:**

[Chapter 7.1 Leveling Instructions](#)

4. Once level has been confirmed, replace both side covers using a #2 Phillips head screwdriver.

7.4 Gas Assist Handrail Overview

The 4 Front Medical Handrail Gantry Assembly offers enhanced safety protocols tailored to suit professional physical rehabilitation therapists and professional medical rehabilitation environments.

Medical Handrail assemblies are fully adjustable in height and width, while the **Control Console and Handrail Controls (1)** have multiple adjustment/placement options.

[See 7.4.1 for details](#)

The **Front Cross Bar (2)** can be left in the down position as a front grab bar or may be swung up and out of the way.

Safety protocols dictate the front handrail be mounted/secured so that forward and back movement is not permitted. [See 7.4.2 for details.](#)

Both **Left (3)** and **Right (4)** Handrails are independently adjustable and may be adjusted in or out, and up and down.

Up/Down adjustments utilize gas charged cartridges to aid in adjustments. [See 7.4.3 for details.](#)

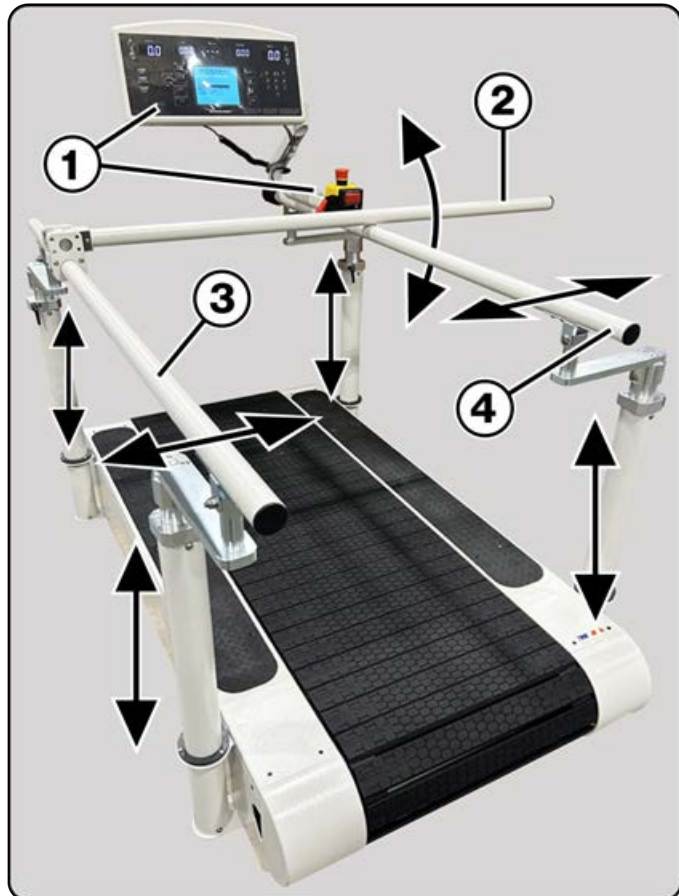

7.4.1 Control Adjustments

The **Main Control Console (1)** is mounted to a multi-axis support arm that allows to control panel to swivel, swing, and tilt to best suit the intended use.

This enables caregivers to control the treadmill from the side, leaving the patient to focus on the therapy/training task.

Handrail Controls (2) may also be moved to best suit the intended use.

There are no locking mechanisms, for the control console adjustments, simply hold the control console on each side and position where it is best suited.

Note: [See Maintenance Sub Chapter 12.5.5](#) for Support arm tension adjustments.

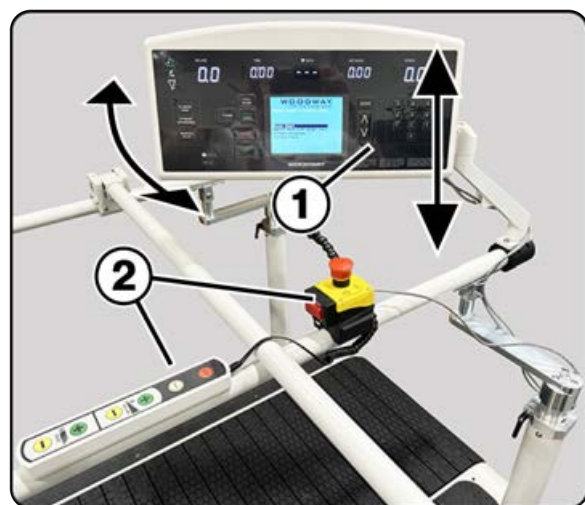

Handrail Controls (2) and Emergency Stop (1)

have magnetic mounts, allowing them to be positioned wherever is best suited.

Simply pick the units up off the handrail, and position where needed.

Note: There is excess wire for each of the controls to allow proper placement. Ensure the excess wires are wrapped up and positioned as not to be a trip hazard.

Activating the Emergency Stop causes immediate power disconnection to the drive system.

The running surface comes to a gradual but short stop, without sudden braking that could cause undue stress to the user.

It is recommended to familiarize yourself with the treadmills braking performance (Emergency Stop) at various speeds.

To activate the Emergency Stop firmly press down on the Red Button.

To release the Emergency Stop, hold the Base and pull UP on the Red Button.

If equipped with a Twist Type Emergency Stop turn the Red Button counterclockwise until the Button pops up.

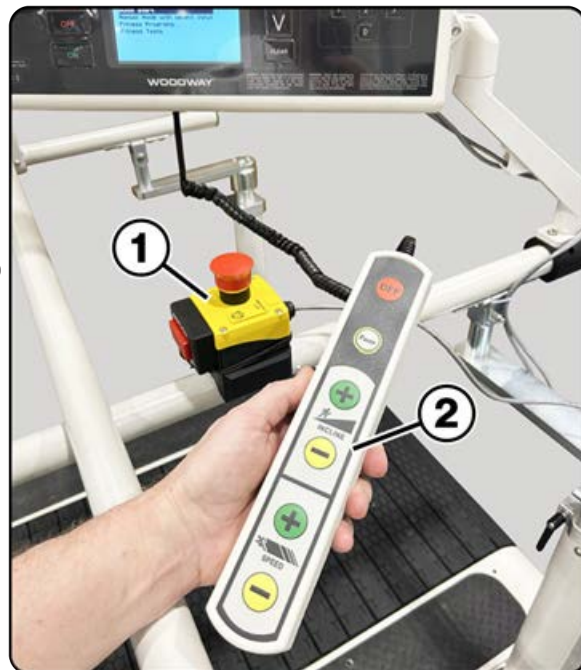

7.4.2 Front Cross Bar Adjustment

Although the Front Cross Bar is fixed from movement front to rear, it can be swung up and out the way if needed.

1. Remove the **Safety Limit Pin (A)** from the out-board port.
2. Raise the **Front Cross Bar (B)** to its vertical position.
3. Re-install the **Safety Limit Pin (C)** into the in-board port.

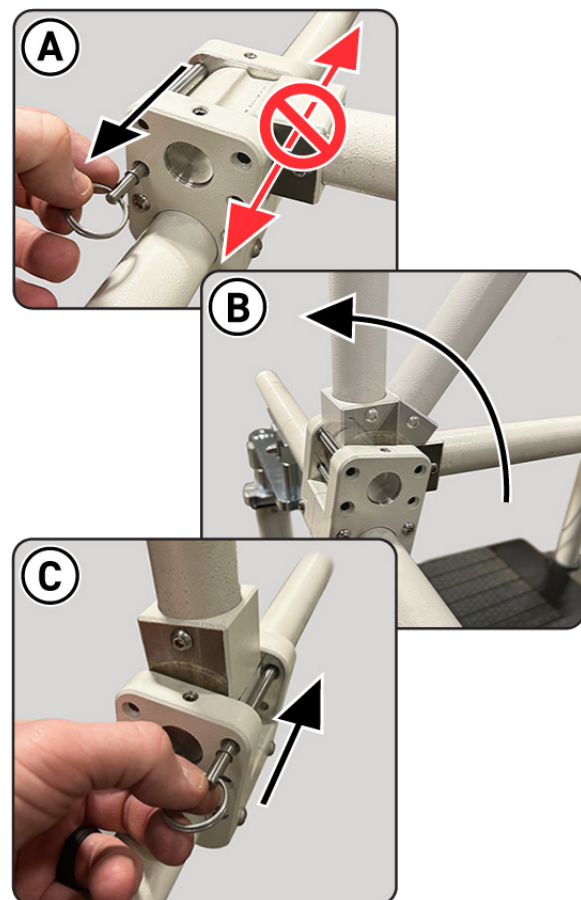

7.4.3 Side Handrail Adjustments

Handrail Width Adjustment.

Each Left and Right Handrail Assembly can be adjusted in or out to create a narrower or wider Handrail Assembly.

The Handrails are supported by **Vertical Stanchions (1)** incorporating locking collars at each corner. **Locking Handles (2)** are used to loosen or tighten the locking collars.

With both front and rear collars loosened the Handrail assembly may be rotated in-wards or out-wards to modify the Handrail width.

When the correct width has been determined tighten Both front and rear **Locking Handles (2)** Securely.

Note: Test the Security/Tightness of the locking collars by pushing/pulling the handrail in-wards and out-wards insuring it is secured and does not slip or move.



Handrail Height Adjustment.

Each Left and Right Handrail assembly can be adjusted up or down to best suit the needs of the user.

The Handrails are supported by Vertical Stanchions incorporating gas filled cartridges to aid in the raising and lowering of the Handrail assemblies.

Locking collars at each corner must be loosened using the Locking Handles (3), with the collars loose the Handrail assembly may be raised or lowered.

A “Push Button” (1) on the top of each support post, must be pushed down to allow the gas cartridge valving to assist in the raising and lowering of the Handrail assembly.

Note: The Handrails don't necessarily need to be parallel or level, and both right and left handrails may be adjusted independently. There are **Measuring Rules (2)** on each of the support posts that can be used for reference and documentation.

Keep in mind that the Handrail assembly is attached to the main chassis of the treadmill and any adjustments to the incline will also affect the handrail.

IMPORTANT: When making Front to Rear Handrail Height Adjustments, BOTH Front and Rear **Locking Handles (3)** should be in a “Loose”/“Unlocked” state until BOTH Front and Rear height adjustments are finalized and confirmed.

Only after the set height is confirmed should the Height Adjustment **Locking Handles (3)** be securely tightened.

Note: Test the Security/Tightness of the locking collars by pushing/pulling the handrail in-wards and out-wards insuring it is secured and does not slip or move.



7.5 Completion of Installation

Checklist for Before Starting Operation Prior to starting operation, installation is to be completed with a trial run. During the trial run, all device functions are to be carried out and checked.

- Check level and sturdiness of the device
- Check electrical connections (Correct incoming Voltage and Plug Type)
- Ensure covers are in place protecting users from moving components
- Ensure that safety equipment is intact and functional
- Check and confirm Emergency Stop switch and all control functions operate as intended
- Perform a malfunction-free trial run
- Ensure all operators have received complete and proper instruction
- Ensure safe fall areas are clear of any potential hazards

ATTENTION BA1
<p>Check Device</p> <p>After the trial run has been carried out, all bolted connections, couplings, and other connections are to be checked for tightness.</p>

8 Operation

WARNING 06
<p>Danger Through Uncontrolled Running Surface Movement!</p> <p>By stepping on the rear-most part of the running surface where it is rounded, the force of gravity can set the running surface in motion. There is a danger of falling.</p> <ul style="list-style-type: none"> • Ensure that the user does not step on the rounded part of the running surface when mounting and dismounting.

8.1 For Your Safety

For safe operation and successful training please read the following points for your own safety before starting to use the treadmill:

- Keep hanging clothing and towels away from the running surface. Ensure that shoelaces do not extend beyond the bottom of the shoe sole.
- Keep the area behind the treadmill clear and make sure that there is a space of at least 80 in. (2 m) between the rear of the treadmill and walls or furniture.
- Keep hands away from all moving parts.
- Children and animals may not mount the treadmill! Never leave children or animals near the treadmill unattended.

- Check the treadmill for defective or loose components before use and replace or repair if necessary.
- Mount and dismount the treadmill carefully. Never mount or dismount the treadmill when the running surface is moving.
- For safety reasons and in the case of an emergency dismount, hold on to the handrail and straddle the running surface with your feet on the left and right-side panels.
- Do not dismount the treadmill until the running surface stops moving.
- Wear suitable running shoes with a high degree of grip. Do not wear shoes with heels or leather soles or running shoes with spikes.
To protect your device, ensure that there are no stones in your shoe soles.
- Take a few minutes to get your heart rate in the desired training range. Walk slowly for some time after a training session to give your body enough time to cool down. During this time your heart rate will go back to the normal range.
- Never let loose objects (e.g. balls) roll under the treadmill. They could be pulled into the device during operation.

ATTENTION

BA9

The user/owner or representative of the equipment is responsible for ensuring that regular maintenance and inspection of the treadmill is carried out.
Defective components must be replaced immediately. The treadmill should not be used until it is repaired by a professional.

8.2 Practical Training

NOTICE

BN3

CONSULT A DOCTOR!

If you are over 40 years old, have a heart condition, are overweight, or have not been involved in an exercise program for several years, a visit to the doctor is recommended before beginning an intensive training program.

8.2.1 Professional Consultation

For all treadmill training beginners, it is recommended to seek the advice of a professional fitness instructor or personal trainer, to obtain an overall fitness assessment before starting an exercise program and develop an optimal training program.

For optimal use and safety during treadmill training, WOODWAY recommends running on the treadmill in an upright and natural running position and avoid dragging foot movement.

8.2.2 Warm-Up and Cool Down

A warm-up before each workout and a cool-down after each workout is recommended. If possible, you should always do some basic stretching exercises for the legs before and after training.

The stretching exercises make you more flexible which prevents muscle soreness and injury during routine activities.

8.2.3 Proper Body Form

When running or walking, it is important to maintain proper form to maximize efficiency and results and minimize the possibility of personal injury.

Keep your posture upright; avoid leaning forwards or backwards from the waist, as this can cause unnecessary back strain and decrease your efficiency.

Keep your head, shoulders, and hips in line with each other and aim to have your foot strike the running surface in line with your center of gravity (i.e. you should strike the running surface with the mid-foot or forefoot).

If you land on your heels, you are over-striding and should shorten your stride to increase momentum and overall efficiency.

Keep your arms at your sides, either relaxed and naturally pendulum-like (walking) or with a loose 90-degree angle, bending at the elbows (running).

Do not allow your hands to cross the center of your body or your shoulders to move from side to side.

8.2.4 Rehabilitation / Training Frequency

Endurance Rehabilitation / Training

At the beginning of rehabilitation training the user should follow their medical professionals' recommendations and limitations, allowing for sufficient time to rebuild physical condition. The priority is regularity and persistence of rehabilitation / training - not intensity.

Experts recommend in the beginning training 3 - 4 times per week within your target heart rate for at least 20 minutes per workout.

Your primary objective should be, step-by-step, to reach a level of fitness with which you can easily keep your heart rate in the target range for 50 to 60 minutes, 4 - 5 times per week.

Running Shoes

To prevent sore feet and sore muscles caused by incorrect footwear, the use of high quality running or jogging shoes is recommended. Ensure there is adequate heel and arch support.

8.2.5 Measuring Heart Rate

To select the optimum fitness levels for the workout, it is important to determine your heart rate and pulse as accurately as possible.

For this, the use of a high-quality heart rate monitor is recommended.

If you do not have a heart rate monitor, you can take your pulse by placing your fingers on the underside of your wrist or on one side of your neck.

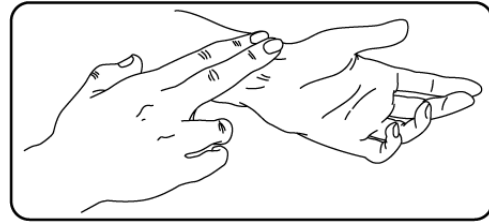

Look at the second hand of a clock and count how many beats you feel in 15 seconds.

Multiply this number by 4 to calculate the BPM (beats per minute). Your heart rate is required when you do your fitness test.

8.2.6 Calculating Heart Rate Measurement

Determine Heart Rate

For selecting the individual training intensity, it is important to determine one's own heart or pulse rate. For this, the use of a heart rate monitor is recommended.

The pulse can also be determined by placing the middle and index fingers together on one side of the neck (a few centimeters outward from the larynx).

Count the number of beats within a 15 second period and multiply by 4 to determine the beats per minute (BPM).

Maximum Heart Rate

To determine your maximum heart rate subtract your age from the number 220 (general formula). The difference is an approximation of your maximum heart rate.

This formula is used by the American Heart Association (AHA) and the American College of Sports Medicine (ACSM).

Your actual maximum heart rate is determined by a stress test performed by your doctor.

The American Heart Association recommends undergoing a stress test if you have a history of heart disease or if you are over 40 years old and starting an exercise program.

Heart Rate Recommendation

During training it is recommended not to exceed a value of 85% of your maximum heart rate. Our programs are designed so that the heart rate remains within the target range.

Your target range is between 60 and 75% of your maximum heart rate.

If you find that your heart rate is above the 75%, you are probably running too fast. Reduce your speed or stop your workout for a moment to bring your heart rate back to the target range.

Use the following chart to determine your heart rate range:

Age	Maximum Heart Rate (BPM*)	60% of Max Heart Rate (BPM*)	75% of Max Heart Rate (BPM*)	85% of Max Heart Rate (BPM*)
20	200	120	150	170
25	195	120	150	160
30	190	110	140	160
35	185	110	130	150
40	180	100	130	150
45	175	100	130	140
50	170	100	120	140
55	165	90	120	130
60	160	90	120	130
65	155	90	110	130
70	150	90	110	120
75	145	80	100	120

8.2.7 Contact Heart Rate Monitors

Grips located on the front cross bar of the handrail transmit the user’s Heart Rate. The transmission begins when the user holds the grips.

After starting the device, the user may hold the grips for a heart rate measurement at any time.

Please wait 60 seconds to obtain an accurate Heart Rate reading. The user’s Heart Rate is automatically displayed on the Main Control Panel under “Heart rate”.

NOTICE
<p>The measurement of the Heart Rate using the Grips is not as exact as EKG and is only considered an approximation.</p>

The display was designed so that the user's Heart Rate is indicated when compatible heart rate transmitters are used, i.e. POLAR® measuring device (GymLink compatible) and ANT+.

To display the user's heart rate accurately on the screen, the built-in receiver display must receive a stable heart rate signal from the transmitter.

Please visit www.polar.com/us-en and <http://www.thisisant.com/directory/> to view a full list of monitors and devices with POLAR® (GymLink) and ANT+ compatibility.

Heart rate measuring systems consists of three main elements:

- Sensor/transmitter
- Chest strap/belt or sport watch
- Measuring device/console

The receiver for the wireless system is installed in the measuring device assembly or the console display. When in operation the display shows the heart's activity in beats per minute (BPM).

 WARNING 07	
Danger of Electrical Disturbance!	
<ul style="list-style-type: none">• Using the transmitter from the heart rate monitor in conjunction with an electric pacemaker may cause electrical interference and influence the functionality. This could cause a health hazard.• Never use the heart rate monitor together with an electric pacemaker.	

8.2.9 Applying the Chest Strap

The transmitter should be applied centrally below the chest muscles.

After the belt is fastened, pull it away from the chest by stretching the strap and moistening the conductive electrode strips which are located below the buttons.

The transmitter operates automatically while it is worn.

It does not work if the connection between the transmitter and the body is broken.

Refer to Heart Rate Monitor Owners Manuals for further specific details.

Positioning

The sensor/transmitter is to be worn below the chest and above the abdomen, preferably directly on the skin (not over clothing), logo to the outside.

Moisten the contact surface of the transmitter in order to transmit the best signal possible from the body to the measuring device.

Cleaning

The chest strap can be washed. Remove the belt from the transmitter, taking care not to bend the electrodes. Wash the strap and electrodes with warm water and mild soap.

Do not machine wash the electrodes and do not use alcohol or other harsh cleaning solvents.

Since the transmitter can be activated by moisture, it should be wiped dry after cleaning.

Never use force to clean the transmitter.

Transmission / Receiver Signal

The transmitter has a range of about 3 ft. (1 m). Depending on the model, the receiver is located in the display or on the handrail cross bar.

When positioning several treadmills next to each other ensure that a minimum distance between the devices is kept to avoid the interference of the transmission signals between runners.

8.2.10 Transmitter Function

The signal will only be transmitted if the transmitter is within 3 ft. (1 m) of the receiver.

Note that variations in the heart rate display can occur when the transmitter is too close to other heart rate measuring devices. Maintain at least 3 ft. (1 m) distance from other devices.

NOTICE

BN4

It is possible that the heart rate measurement reception is irregular or completely disrupted when the measuring device is too close to strong sources of electromagnetic radiation, for example, in the vicinity of overhead power lines, televisions, computers, electric motors, or other fitness equipment.

Only one transmitter should be used within range of a receiver since the receiver might otherwise receive multiple signals and transmit inaccurate readings.

9 Quick Set Display

9.1 Overview of Control Console

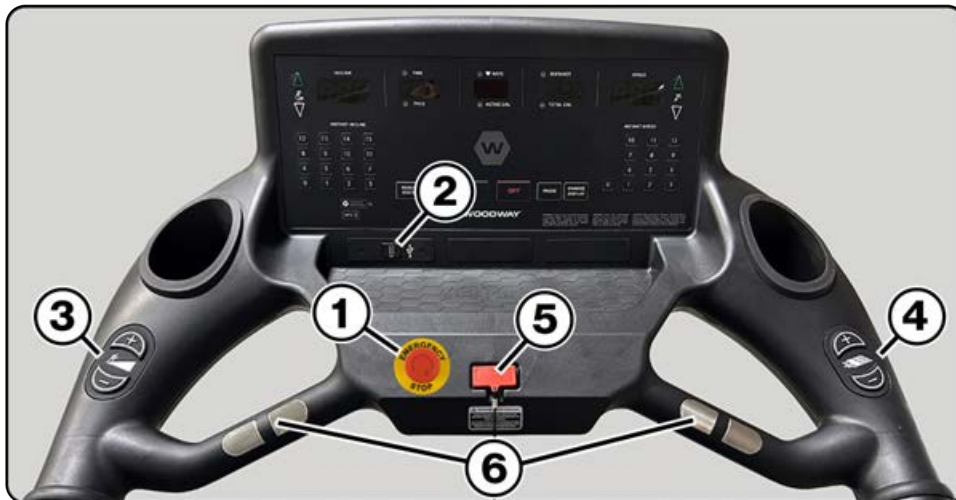

The Quick Set Model Main Control Console utilizes membrane style push buttons that provide users with full control over desired settings such as speed, incline, modes, and general operation.

The 4 Front Medical Model utilizes an **Emergency Stop Push Button (1)** on the main Control Console.

USB Charging Port (2) allows users to charge their phones/USB devices, also used for software updates.

Quickset Incline Handrail Button (3) allows the user quick increment adjustment of the incline.

Quickset Speed Handrail Button (4) allows users to incrementally increase/decrease speed settings.

A Magnetic Safety Tether (5) is located in the center of the console, the clip end of the tether should be clipped to the user to ensure if they were to leave the running surface, the unit will automatically shut off.

Sensor Grips (6) located on the front cross bar transmit the user's heart rate. After starting the treadmill, the user may hold the grips to transmit a heart rate measurement at any time, which will display on the top center of the control panel.

NOTE: When using the Sensor Grips, wait 60 seconds to obtain an accurate heart rate reading.

NOTICE

The measurement of the heart rate using the grips is not as exact as EKG and is only considered an approximation.

One of the unique features of WOODWAY Pro and Pro XL models are an additional set of Quickset Buttons on the lower right Handrail assembly.

By using the Handrail Controls the user can adjust the Speed and/or Incline without leaning over the display, allowing the user to continue running and minimizing the risk of losing the balance and/or falling.

Quickset buttons allow the user to quickly **Stop (1)** or adjust the **Incline (2)** as well as **Speed (3)** settings.

NOTE: All 4 Front models have Quickset buttons located just below the control console on each handrail.

PRO / PRO XL MODELS

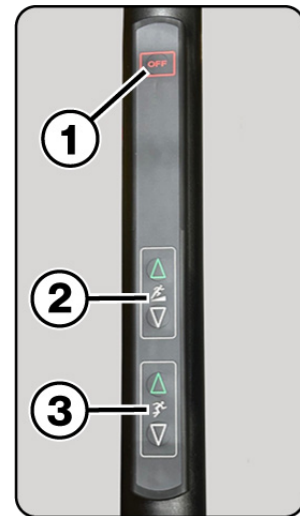

Description of Display Elements

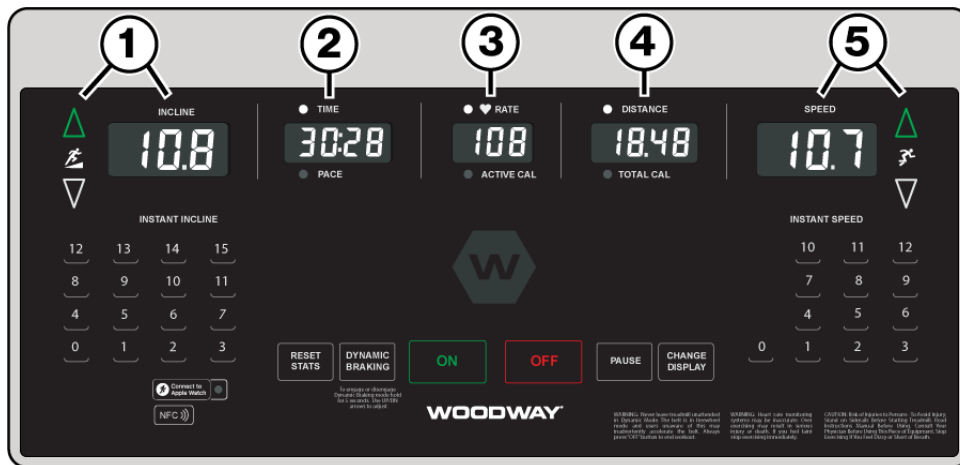

INCLINE (1) displays the user's current incline setting; values start at 0.0 use the Quickset Up/Down arrow buttons to increase or decrease the incline in 0.1 increments. The incline may also be adjusted using the plus/minus buttons located on the left side handrail.

Note: The -3 to +22 incline option requires the user to press and hold the Negative Incline button for 5 seconds to go to the Negative position. To return the zero position the user must press and hold the Positive Incline button for 5 seconds.

TIME/PACE (2) Time is displayed in 00:00 format and is counted up from zero. Pace represents the time required to run one mile/kilometer at the current speed.

HEART RATE/ACTIVE CALORIES (3) Heart Rate is displayed in 000 beats per minute (BPM) format. It represents the user's actual real time heart rate. There are contact heart rate grips on the cross bar that will display the users heart rate when the user makes contact for 60 or more seconds. Or the unit may be paired with an ANT+ or POLAR® compatible heart rate transmitter.

Calories are displayed in 0000 format. "ACTIVE CAL" shows the user's current calorie burn during the workout. Calculated using the ACSM formula, based on a standard weight of 150 lbs. (70 kg.)

DISTANCE/TOTAL CALORIES (4) Distance is displayed in 00.00 format. Distance shows the accumulated user's distance in miles/kilometers. The distance is accumulated until the program is terminated or the user presses the PAUSE button.

Calories are displayed in 0000 format. "TOTAL CAL" shows the user's accumulated calories burned during the workout. Calculated using the ACSM formula, based on a standard weight of 150 lbs. (70 kg.)

SPEED (5) is displayed in 00.0 format. SPEED represents the user's current speed in mph/kph. Use the Quickset Up/Down arrow buttons to increase or decrease the speed or adjust using the Plus/Minus buttons located on the right-side handrail. Valid speeds range from 0. to the maximum speed (which varies depending on the model and application). Up/Down arrow buttons change speeds at 1/10 mph/kph increments.

Description of Display Elements

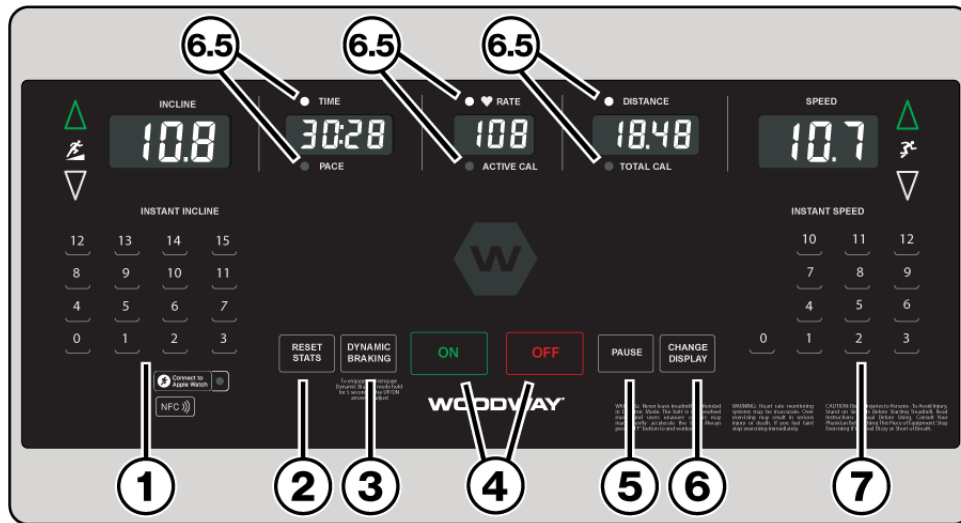

INSTANT INCLINE (1) Pressing any the numeric buttons 0 through 15 will set the Incline to the desired setting, without the need to press the Up/Down Incline Arrow Buttons multiple times.

RESET STATS (2) Pressing the RESET STATS Button will reset the Time, Pace, Heart Rate, Active Calories, Distance, and Total Calories to zero.

DYNAMIC BRAKING (3) Allows the user to set the treadmill belt into a “Free Wheel” mode which the user serves as the running surface belt drive. Meaning the user drives the running surface belt manually during training, this is known as “Dynamic Mode”.

To activate, press and hold the “DYNAMIC BRAKING” Button until the Speed Display begins to flash, then use the speed buttons to increase/decrease the amount of resistance on the belt.

ON/OFF (4) Pressing the ON button will turn on the LED displays and enable all control function buttons. Pressing the OFF button will return the speed and incline to zero and turn off the LED display ending the workout session.

PAUSE (5) When the user presses the PAUSE Button, the treadmill stops. The TIME/PACE display indicates “PAUS” and the other displays maintain the values from the time that the PAUSE Button was pressed. Press the PAUSE Button again to resume training. The speed is increased to the former value and the TIME display starts counting the time.

CHANGE DISPLAY (6) Pressing the Change Display Button while the treadmill is in use will change the display metrics for the **Top 3 LED Segments (6.5)** a White LED will illuminate next to the Active display function to show the user which metrics are chosen.

INSTANT SPEED (7) Pressing any of the numeric buttons 0 through 12 will set the Speed directly to the desired setting, without the need to press the Speed Increase/Decrease Buttons multiple times.

9.2 Starting/Finishing a Workout

To Start a workout, press the “Speed Increase” Up Arrow (1) or any of the “Instant Speed” Buttons (2) to begin a workout.

The LED's will display the current statistics, and the timer will start to count up from 00:00.

To Finish a workout, press the “OFF” Button at any time to end a workout session.

The Speed and Incline will reset to zero, while the workout statistics will display for 10 seconds before the LED's turn off.

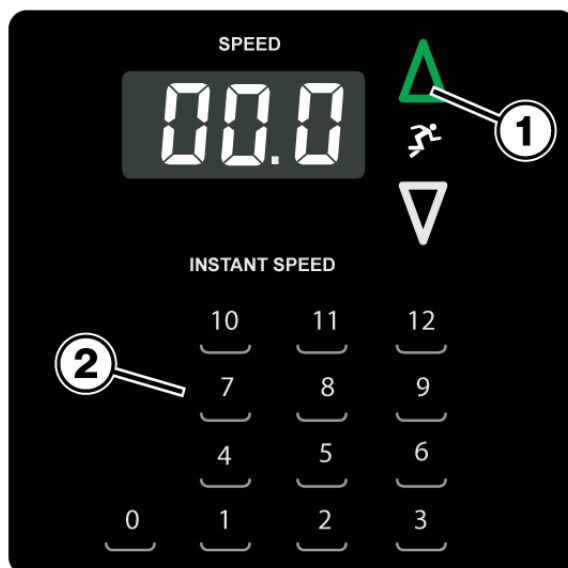

9.3 Dynamic Mode

013
WARNING

Do Not Leave Treadmill Unattended While in Dynamic Mode!

If the treadmill is left unattended while in Dynamic Mode, there is a possibility of personal injury from people stepping onto device while assuming the running surface is locked.

- Never leave treadmill unattended while in Dynamic Mode.
- The running surface runs completely free in both directions and is no longer slowed by the motor.
- Always keep children and animals clear of the treadmill while in Dynamic Mode.

In “Dynamic Mode” the user serves as the running surface “Drive” force, by manually driving the belt surface during a workout.

To **Enter Dynamic Mode**, proceed as follows:

1. Reduce both SPEED and INCLINE to zero and step onto side rails.
2. Press and hold the **DYNAMIC BRAKING (1)** Button until the Speed Display begins to flash, then use the speed buttons to increase/decrease the amount of resistance on the belt.



To **Leave Dynamic Mode**, proceed as follows.

1. Reduce INCLINE to zero and step onto side rails.
2. Press and hold the DYNAMIC BRAKING Button until the Speed Display begins to flash.

Alternatively, the treadmill can be switched off by pressing the OFF key. When the device is switched back on it will automatically be in normal operating mode and Dynamic Mode will be deactivated.

9.4 Saving Workouts to USB

With the 4Front treadmill, it is possible to save your workout information to a USB device to review on your computer and track your personal training progress over time.

1. Insert USB stick into USB port beneath 4Front interface display.
2. Turn the treadmill ON. The treadmill will begin recording data to the USB from whatever time you insert it into the USB port until you finish training.
3. After inserting the USB, the LED display should light up "USB Good" if the USB is compatible.
 - If the USB is incompatible or full, the LED display will light up "USB OFF".
 - If the USB is incompatible, a different USB will be necessary.
4. After completing workout, press the OFF button once and the screen will flash "USB Save".
5. Remove USB after the display powers down.



9.5 Uploading Data to Computer

The saved file (.XML format) contains your workout data including workout time, calories burned, distance (miles), speed (MPH), pace (s/mi), incline (%), vertical feet, heart rate (BPM), and METs.

1. Plug your USB into the computer.
2. Upload the .XML file to a designated folder on your computer.

9.6 Excel Importing

View your workout data through any of the following methods:

One method to view your raw workout data and compare multiple training sessions is through Microsoft® Excel.

1. Open Excel.
2. From the toolbar, select "Data" > "From Other Sources" > "From XML Data Import" option.
3. Locate your USB storage device, select a single workout, and click "Open".
 - A message box may pop up saying that Excel does not recognize the schema. Click "OK" and click "OK" again on the next pop-up.
 - The next screen will appear with all the raw data from your workout.
4. To compare another workout, click "Sheet2" at the bottom of the window and follow the above instructions to upload the second workout.

10 Personal Trainer Display

10.1 Overview of Control Console



The Personal Trainer Model main control panel utilizes membrane style push buttons that provide users with full control over desired settings such as speed, incline, modes, and general operation.

While the LCD Screen displays current training mode, detailed graphs and workout progress. The 4 Front Medical Model utilizes an **Emergency Stop Push Button (1)** on the main Control Console.

USB Charging Port (2) allows users to charge their phones/USB devices, also used for software updates.

Quickset Incline Handrail Button (3) allows the user quick increment adjustment of the incline.

Quickset Speed Handrail Button (4) allows users to incrementally increase/decrease speed settings.

A Magnetic Safety Tether (5) is located in the center of the console, the clip end of the tether should be clipped to the user to ensure if they were to leave the running surface, the unit will automatically shut off.

Sensor Grips (6) located on the front cross bar transmit the user's heart rate. After starting the treadmill, the user may hold the grips to transmit a heart rate measurement at any time, which will display on the top center of the control panel.

NOTE: When using the Sensor Grips, wait 60 seconds to obtain an accurate heart rate reading.

NOTICE

The measurement of the heart rate using the grips is not as exact as EKG and is only considered an approximation.

One of the unique features of WOODWAY Pro and Pro XL models are an additional set of Quickset Buttons on the lower right Handrail assembly.

By using the Handrail Controls the user can adjust the Speed and/or Incline without leaning over the display, allowing the user to continue running and minimizing the risk of losing the balance and/or falling.

Quickset buttons allow the user to quickly **Stop (1)** or adjust the **Incline (2)** as well as **Speed (3)** settings.

NOTE: All 4 Front models have Quickset buttons located just below the control console on each handrail.

PRO / PRO XL MODELS

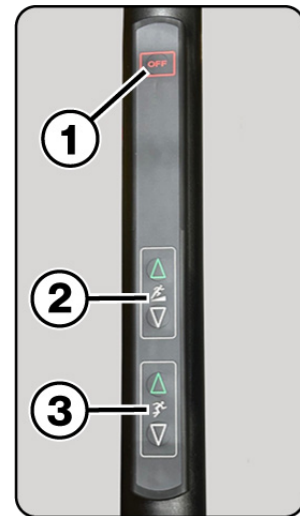

Description of Display Elements

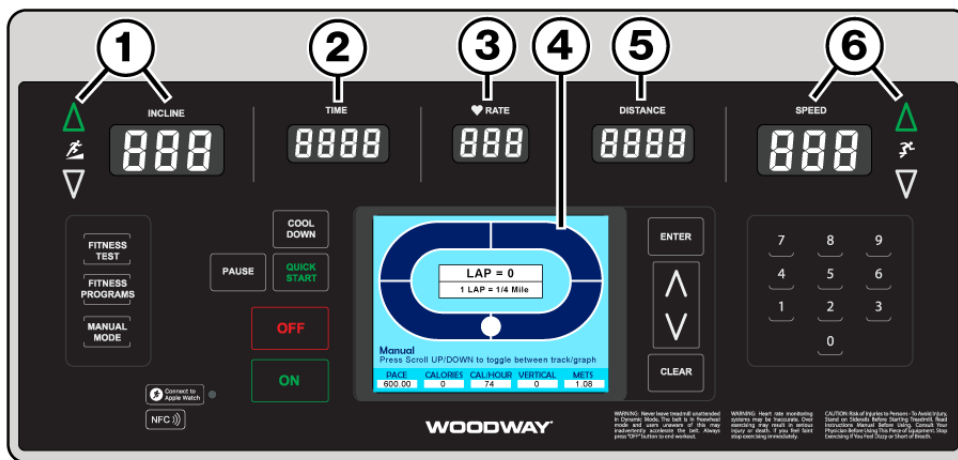

INCLINE (1) Displays the user's current incline setting; values start at 0.0 use the Quickset Up/Down arrow buttons to increase or decrease the incline in 0.1 increments. The incline may also be adjusted using the plus/minus buttons located on the left side handrail. (Maximum incline is dependent upon the model and chosen elevation option).

TIME (2) Is displayed in 00:00 format. In the user-defined mode, the time is counted Up from zero. In program modes, the time is counted down.

HEART RATE (3) Is displayed in 000 beats per minute (BPM) format. It represents the user's actual real time heart rate. There are contact heart rate grips on the cross bar that will display the users heart rate when the user makes contact for 15 or more seconds. Or the unit may be paired with an ANT+ or POLAR® compatible heart rate transmitter.

LCD DISPLAY (4) Displays detailed information on a more metabolic level while giving users access to training parameters and graphs for a wide range of preset and user defined training modes.

Membrane push buttons located on the main control panel are used to select and enter information for desired training modes, based on simple to follow screen highlights and prompts.

DISTANCE (5) Is displayed in 00.00 format. Distance shows the accumulated user's distance in miles. The distance is accumulated until the program is terminated or the user presses the PAUSE button.

SPEED (6) Is displayed in 00.0 format. SPEED represents the user's current speed in miles per hour (MPH), or it may be used to set the user's target speed in certain training modes. Use the Quickset Up/Down arrow buttons to increase or decrease the speed or adjust using the Plus/Minus buttons located on the right-side handrail. Valid speeds range from 0. to the maximum speed (which varies depending on the model and application).

Description of Display Elements

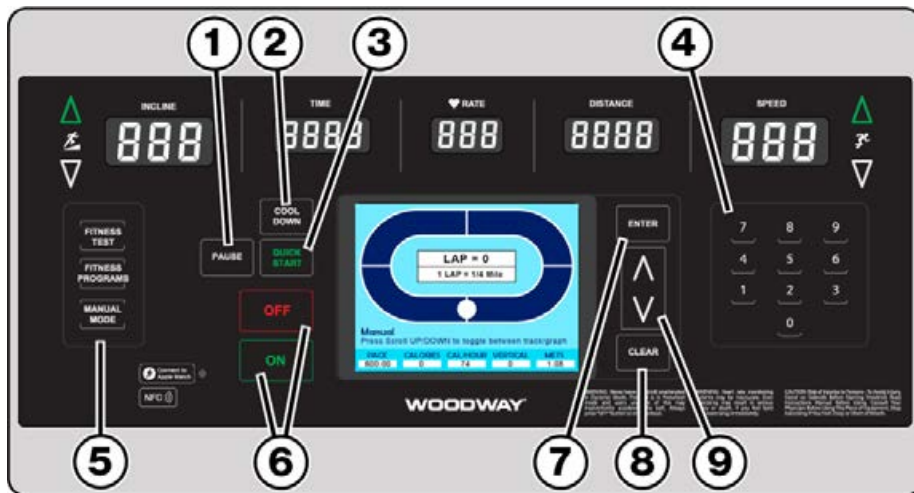

PAUSE (1) When the user presses the PAUSE button, the treadmill slows to a stop. The LCD will display: "treadmill paused press pause to resume". The statistics are also paused when the PAUSE button is pressed, when the user presses the PAUSE button again, the workout resumes.

COOL DOWN (2) Automatically decreases the treadmill belt speed gradually over a two minute time span at which time the belt will slow from the current speed down to 2.5 mph, finishing the workout in a controlled pace.

QUICK START (3) The Quick Start button, starts the timer and allows the user to manually set the speed and incline using the Quickset Up/Down arrow buttons on the main control panel or from the Plus/Minus buttons on the handrails.

NUMERIC KEYPAD (4) Used to enter information for various fitness programs, tests, and workout modes. When the treadmill is in use the numeric keypad can be used as a quick select to set the speed. (Press the desired number then press ENTER)

MODE BUTTONS (5) Gives the user quick access to fitness tests, fitness programs and manual mode. Pressing any of the three buttons will change the LCD display to the current chosen mode.

ON/OFF (6) Pressing the ON button will turn on the LED and LCD displays and enable all control function buttons. Pressing the OFF button will turn off the LED and LCD displays and end the workout session.

ENTER BUTTON (7) Used to enter desired selections as highlighted in the various program screens on the LCD display.

CLEAR BUTTON (8) The Clear button is only active when the treadmill is not in motion, or the PAUSE button has been pressed. Pressing the CLEAR button will reset all of the treadmill statistics displayed in the lower portion of the LCD screen.

UP/DOWN SCROLL ARROWS (9) Allows the user to scroll through menus and options in the LCD screen when accessing fitness training programs.

10.2 LCD Display Overview

During Quick Start and Manual Mode the LCD screen will initially display a blue oval that represents a 1/4 Mile (400-meter) track, with the white dot as a marker for the user's current position on the track. The lower portion of the display shows current stats based on the user's active workout.

LAP Display (1) Each lap around the track represents 1/4 mile (400 m). The lap counter counts each completed lap.

PACE (2) The pace is displayed in 00:00 format. TIME represents the time required to run one mile at the current speed.

CALORIES (3) calories are displayed in 000 format. CALORIES shows the user's accumulated burnt calories calculated using the ACSM formula, $[(\text{Workout METs}) * 3.5 * [\text{User's weight in kg.}] / 200]$

If no weight is entered, the calories are calculated based on a standard weight of 150 lbs. (70 kg).

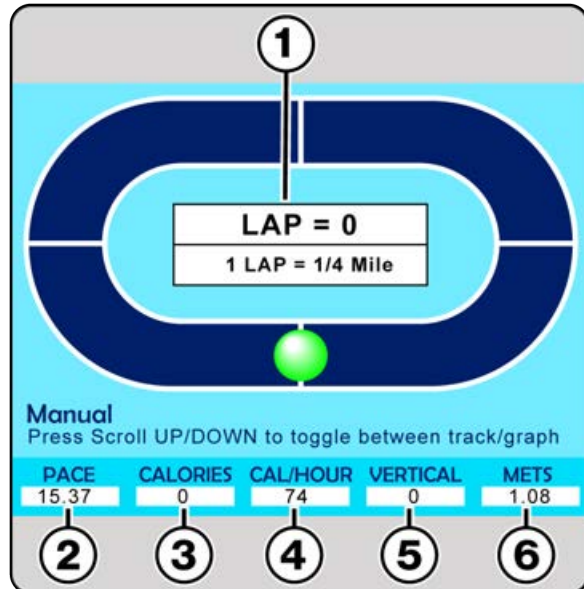

CAL/HOUR (4) Shows user's calories burned per hour based on the current active workout.

VERTICAL (5) Displays vertical distance calculated during workout and based on incline levels.

METS (6) METs are displayed in 00.0 format and are calculated using the ACSM formula, $(\text{VO}_2 \text{ Max} / 3.5)$, where the walking $\text{VO}_2 \text{ Max}$ is $(3.5 + [2.68 * \text{speed in MPH}] + [0.48 * \text{speed in MPH}] * [\% \text{ grade}])$ and the running $\text{VO}_2 \text{ Max}$ is $(3.5 + [5.36 * \text{speed in MPH}] + [0.24 * \text{speed in MPH}] * [\% \text{ grade}])$.

Pressing the UP/DOWN buttons to the right of the LCD will toggle the screen from LAP view to graph display mode.

In Manual Mode the screen displays 3 graphs.

Elevation (1) top red bar graph displays elevation changes throughout the workout.

Speed (2) middle green bar graph displays speed changes throughout the workout.

Heart Rate (3) bottom yellow bar graph displays heart rate throughout the workout.

As the user starts a workout, the bar graphs will show the current status and populate the bar graphs as the workout continues. (manual mode screen shown for reference)

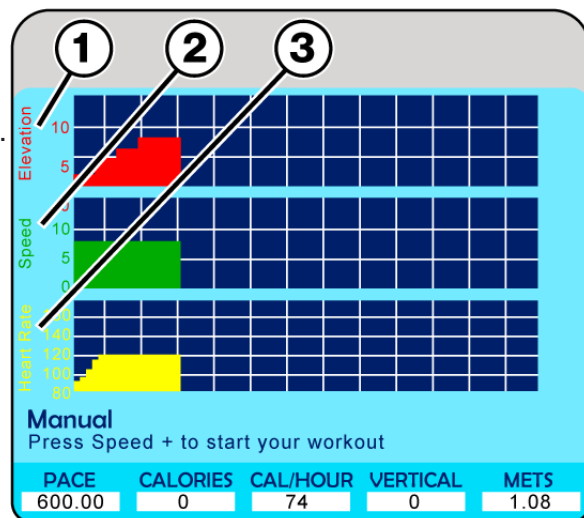

10.3 Quick Start Operation

Upon initial startup of the unit, the LCD screen will display the main menu.

The arrow/scroll buttons to the right can be used to scroll up and down to select the desired mode, pressing the ENTER button will select the highlighted mode.

Note: If starting a workout in this method calories burnt will be calculated based on a standard weight of 150lbs. (70 kg).

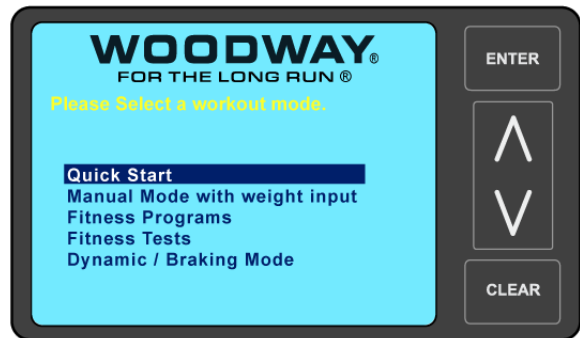

Starting a Workout

With Quick Start highlighted, pressing the ENTER button will change the display to the LAP (manual view).

Pressing either the Up/Down speed arrow buttons on the upper right corner of the main control panel, or the +/- buttons on the right handrail will start the running surface and timer.

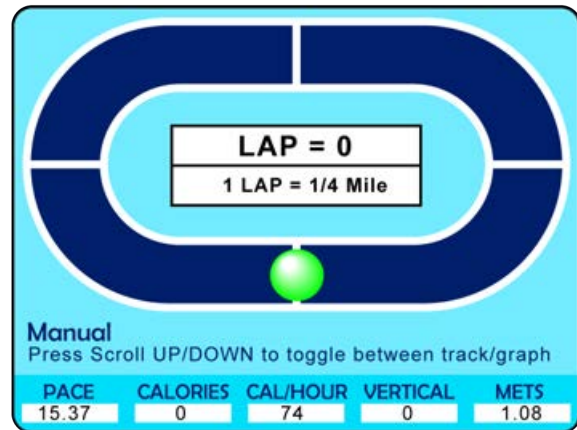

The green dot moves around the “track” showing the users current location based on a 1/4 mile running track, while analytics tabulate on the lower portion of the screen, showing real time data.

At any time during the workout the user may increase or decrease the running surface speed and incline, using either the main control panel buttons or the handrail buttons.

Speed may also be adjusted using the numeric keypad by pressing the desired number (an input pane will appear in the lower right corner of the LCD screen showing the entered value). Press the ENTER button to set the value.

Pausing a Workout

Pressing the PAUSE button pauses the statistics and the treadmill slows to a stop.

The LCD displays “Paused press pause to resume”.

Press PAUSE to resume the workout.

Note: During pause the CLEAR button is active allowing the user to clear/reset the statistics displayed at the bottom of the screen.



Finishing a Workout

Pressing the COOL DOWN button located to the left of the LCD screen automatically decreases the treadmill belt speed gradually over a two-minute time span at which time the belt will slow from the current speed down to 2.5 mph, finishing the workout in a controlled pace.

10.4 Manual Mode with Weight Input

Manual mode operates the same as “Quick Start” the only difference is that manual mode allows the user the enter their body weight to better calculate burned calories.

Manual mode may be accessed by either the LCD main menu or pressing the MANUAL MODE button on the left side of the main control panel.

The initial manual mode screen will display the LAP screen with a **Weight Entry (1)** segment.

Using the numeric keypad, enter the desired weight and press the ENTER button.

The screen will change to LAP view with the analytics bar across the bottom.

At this point the operation for starting, pausing, and finishing a workout is the same as using the unit in Quick Start mode.

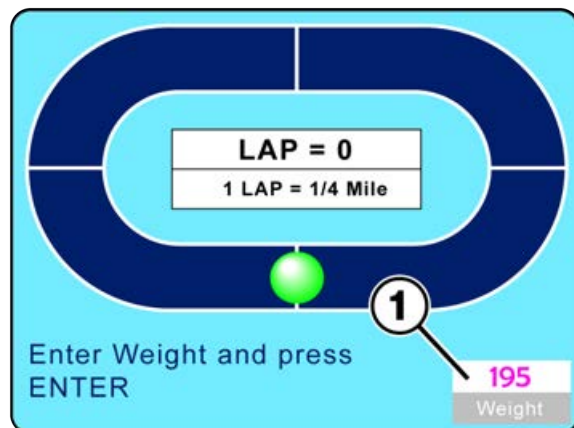

Note: Using the treadmill in either “Quick Start” or “Manual Mode” gives the user full control of speed and incline settings at any time during the workout.

Adjustments can be made by either control panel buttons or handrail buttons.

10.5 Dynamic Mode

WARNING
013

Do Not Leave Treadmill Unattended While in Dynamic Mode!

If the treadmill is left unattended while in Dynamic Mode, there is a possibility of personal injury from people stepping onto device while assuming the running surface is locked.

- Never leave treadmill unattended while in Dynamic Mode.
- The running surface runs completely free in both directions and is no longer slowed by the motor.
- Always keep children and animals clear of the treadmill while in Dynamic Mode.

In “Dynamic Mode” the user serves as the running surface “Drive” force, by manually driving the belt surface during a workout.

To **Enter Dynamic Mode**, proceed as follows:

1. Reduce both SPEED and INCLINE to zero and step onto side rails.
2. Press and hold the **Up/Fast (1)** and **Down/Slow (2)** buttons on the main control panel simultaneously.
3. The display will emit 3 tones. Continue holding the buttons for 5 seconds.
4. Afterwards, one longer tone will sound.

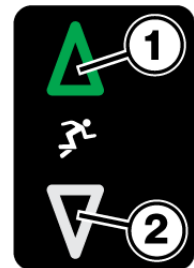

5. The LCD will display “Dynamic Mode”

The treadmill is now set to dynamic mode, the running surface belt is now manually driven by the user.

The speed and incline still display and function as in normal “non-dynamic mode”



To **Exit Dynamic Mode**, proceed as follows.

1. Reduce INCLINE to zero and step onto side platforms.
2. Press the UP/FAST key once to exit dynamic mode.

Note: If the treadmill is turned OFF in dynamic mode, it will automatically revert to normal operating mode when turned back ON.

10.6 Starting a Training Program

Before starting a training program, it is advisable to consult a certified training professional or doctor. Please refer to [Sub-Chapters 8.2.1](#) to 8.2.9 for detailed training, safety and heart rate information.

10.7 Fitness Programs

The 4Front Personal Trainer Model has ten preprogrammed fitness workouts, as well as fitness testing (preloaded U.S. Military, Medical & Fire Department protocols) all accessible from the LCD menu screens.

Although each program has predetermined settings and protocols, each one can be modified on-the-fly to fit the user's current fitness level and goals.

The Fitness Programs menu screen can be selected from either the main startup menu screen by highlighting "Fitness Programs" and pressing the ENTER button.

Or by pressing the FITNESS PROGRAMS button on the Left side of the main control panel.

Blue Sub-Chapter headers below will hyperlink to the desired Fitness Program instruction chapter if viewing this manual with Adobe Acrobat

- [10.7.1](#) Heart Rate Control
- [10.7.2](#) Goal [10.7.3](#) Weight Loss
- [10.7.4](#) Aerobic [10.7.5](#) Interval
- [10.7.6](#) Random [10.7.7](#) Stamina
- [10.7.8](#) Ramp [10.7.9](#) 5 K
- [10.7.10](#) 10 K [10.7.11](#) User Programs

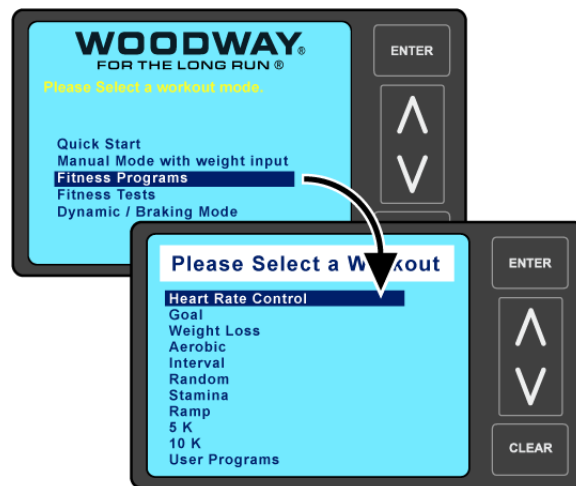

Programs Overview

Once any of the fitness programs have been selected from the main menu screen, the initial screen that will display is referred to as the **“Setup Mode”** screen.

Users enter their specific data, such as Weight, desired Effort Level for the workout (typically 1 to 10 / number 1 being the easiest and 10 the hardest level) and Program Time for the length or duration of the workout.

The right-hand side of the “Setup” screen will display information input panes.

Use the Up/Down arrow buttons to scroll through the input panes the “Active” pane will display in **White (1)**.

When a pane is active use the numeric keypad to enter the desired value, then use the arrow buttons to scroll to the next pane, and enter the desired value until all panes have the desired value.

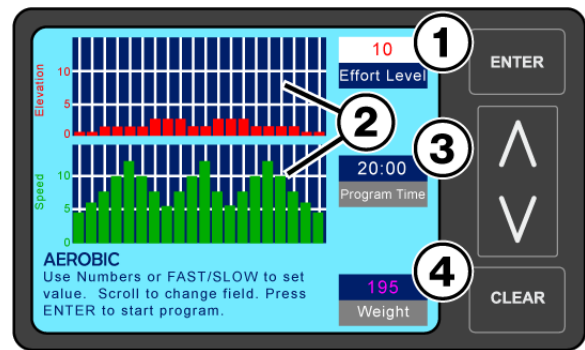

Aerobic “Setup” Screen Shown for Reference

NOTE: Do Not press the ENTER button to set values, this will start the programmed workout. Each time the arrow Up/Down button is pressed the previous value entered will be saved.

The Graph Displays (2) to the left show the preprogrammed Elevation/Incline and Speed metrics for the selected Effort Level.

Program Time (3) Controls the length or duration of the workout (10-99 time range), when a program is initially opened the default time is 20:00 minutes. See Understanding Segments below.

Weight (4) Allows users to enter their weight which is needed to properly track metrics during the workout.

To start the Program, press the ENTER button, the “**Active Mode**” screen will display, and the running surface will start to move.

The timer will start counting from the set value down to zero, while the speed and incline will set to the first preset **Segment Values (1/2)**.

Metrics begin accumulating, which are displayed in the lower portion of the screen.

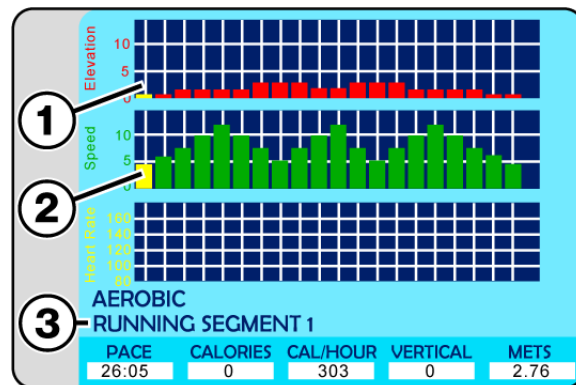

Aerobic “Active” Screen Shown for Reference

While settings/values are automatically adjusted as the program progresses.

As the program starts the first segments will flash yellow, and the current **Segment Number (3)** will be displayed.

Understanding Segments

The graph display breaks down a workout into twenty specific segments, the duration of those segments is determined by the overall time set for the workout.

If the workout time is set for twenty minutes, each segment will last for 1 minute, if the workout time is set to forty minutes each segment will be 2 minutes long.

Whatever the overall time is the segments will be divided evenly.

10.7.1 Heart Rate Control Program

NOTICE BNT1
The automatic heart rate programs can only work effectively if you wear a chest strap for heart rate measurement!

Highlight the Heart Rate Control program and press the ENTER button, the display will show the initial Heart Rate Control Setup” screen allowing the user to input Age, Target Heart Rate, Control Type, Max Speed, Max Time, and Weight.

NOTE: Do Not press the ENTER button to set values, this will start the programmed workout. Each time the arrow Up/Down button is pressed the previous value entered will be saved.

Use the Up/Down arrow buttons to scroll through the input panes the “Active” pane will display in **White (1)**.

Use the numeric keypad to enter the desired value, then use the arrow buttons to scroll to the next pane and enter the desired value until all panes have the desired value.

Each time the arrow Up/Down button is pressed the previous entered value will be saved.

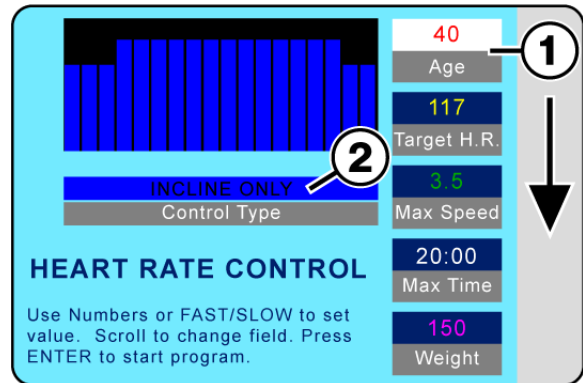

Heart Rate Control Setup Screen

When age is changed the target heart rate automatically updates. (Age range 15-100)

Control Type (2) can be switched from INCLINE ONLY to SPEED ONLY or BOTH by highlighting the pane, then using the Up/Fast or Down/Slow buttons on the speed control portion of the main control panel to make the desired selection.

If INCLINE ONLY is selected, the program controls the incline ONLY.

If SPEED ONLY is selected, the program controls the speed ONLY.

If BOTH is selected the program controls both the incline and the speed.

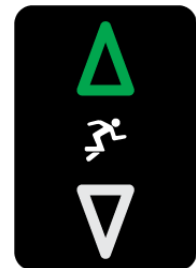

Understanding Control Types

INCLINE ONLY Heart Rate Control program functions as follows:

- If the actual heart rate is 80 beats per minute (BPM) below the target, the incline is not adjusted. As a result, a proper warm-up phase is possible.
- If the actual heart rate is 26-80 BPM below the target, the incline will increase 1% after 15 seconds.
- If the actual heart rate is 6-25 BPM below the target, the incline will increase 1% after 30 seconds.

- If the actual heart rate is 3-25 BPM below the target, the incline will increase 0.5% after 30 seconds.
- If the actual heart rate is at least 3 BPM above the target, the incline will decrease 1% after 15 seconds.
- There is no adjustment when the actual heart rate deviates from the target by a maximum of 2 BPM.

SPEED ONLY Heart Rate Control program functions as follows:

- If the actual heart rate is 80 beats per minute (BPM) below the target, the speed is not adjusted. As a result, a proper warm-up phase is possible.
- If the actual heart rate is 26-80 BPM below the target, the speed will increase 0.4 MPH (0.64 km/h) after 8 seconds.
- If the actual heart rate is 6-25 BPM below the target, the speed will increase 0.2 MPH (0.32 km/h) after 15 seconds.
- If the actual heart rate is 3-5 BPM below the target, the speed will increase 0.1 MPH (0.16 km/h) after 15 seconds.
- If the actual heart rate is at least 3 BPM above the target, the speed will decrease 0.2 MPH (0.32 km/h) after 15 seconds.
- There is no adjustment when the actual heart rate deviates from the target by a maximum of 2 BPM.

BOTH (Incline/Speed) Heart Rate Control functions as follows:

- The speed is increased in increments until 80% of the user's maximum speed is reached (calculation based on user training level input).
- Incline is increased in increments until 10% of the maximum treadmill incline is reached.
- The speed is increased in increments until the user's maximum speed is reached.
- The incline is increased until the maximum treadmill incline is reached.

To start the Program, press the ENTER button. The display will change to "Active Mode" and the timer will start counting from the set value down to zero, while the speed and incline will set to the first preset segment values.

Metrics begin accumulating, which are displayed in the lower portion of the screen. While settings/values are automatically adjusted as the program progresses.

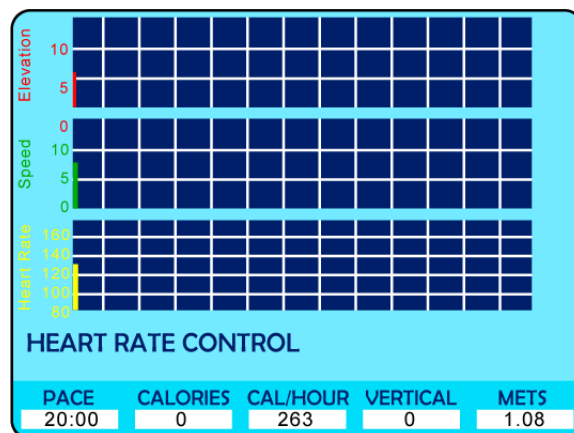

Heart Rate Control Active Screen

Statistics / Metrics are displayed at the bottom of the screen throughout the fitness program duration.

Note: Numeric buttons, CLEAR and ENTER buttons are deactivated while the program is running.

Statistics/Metrics are displayed at the bottom of the screen throughout the fitness program duration.

Pausing the Program

Pressing the PAUSE button pauses the statistics and the treadmill slows to a stop. The LCD displays “Paused Press Pause to Resume”.

Note: During Pause the CLEAR button is active allowing the user to clear/reset the statistics displayed at the bottom of the screen throughout the fitness program duration.

While the program is running, the user can change incline, and speed using either the Up/Down, Fast/Slow buttons on the main control panel, or handrails.

Speed may also be adjusted using the numeric keypad, press the desired number and then ENTER.

When the program is completed, the LCD will read “Program Complete” and the SPEED will reset to zero. Pressing the OFF button will set the incline to zero and turn the LCD screen OFF.

Age	Maximum Heart Rate (BPM*)	60% of Max Heart Rate (BPM*)	75% of Max Heart Rate (BPM*)	85% of Max Heart Rate (BPM*)
20	200	120	150	170
25	195	120	150	160
30	190	110	140	160
35	185	110	130	150
40	180	100	130	150
45	175	100	130	140
50	170	100	120	140
55	165	90	120	130
60	160	90	120	130
65	155	90	110	130
70	150	90	110	120
75	145	80	100	120

10.7.2 Goal Program

Designed as a conditioning program, to build strength and endurance, requiring peak performance in the middle of the training session.

Select Goal from the Fitness Programs menu screen and press the ENTER button.

The Goal "Setup" screen will appear allowing the user to enter their preferences, and weight.

Effort Level (1) There are 10 preprogrammed workouts, 1 = easiest / 10=hardest.

Program Time (2) Controls how the long the workout will last (10-99 time range).

Weight (3) Allows users to enter their weight which is needed to properly track metrics during the workout.

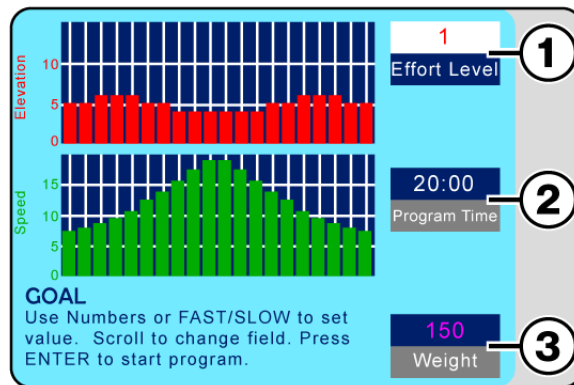

Goal Setup Screen

NOTE: Do Not press the ENTER button to set values, this will start the programmed workout. Each time the arrow Up/Down button is pressed the previous value entered will be saved.

Use the Up/Down arrow buttons to scroll through the input panes the "Active" pane will display in **White (1)** (See Goal Setup Screen).

Use the numeric keypad or Fast/Slow buttons to enter the desired value.

Scroll to the next pane and enter the desired value until all panes have the desired value.

To start the Program press the ENTER button. The display will change to "Active Mode" and the timer will start counting from the set value down to zero, while the speed and incline will set to the first preset **Segment Values (1/2)**.

Metrics begin accumulating, which are displayed in the lower portion of the screen.

As the program starts the first segments will flash yellow, and the current **Segment Number (3)** will be displayed.

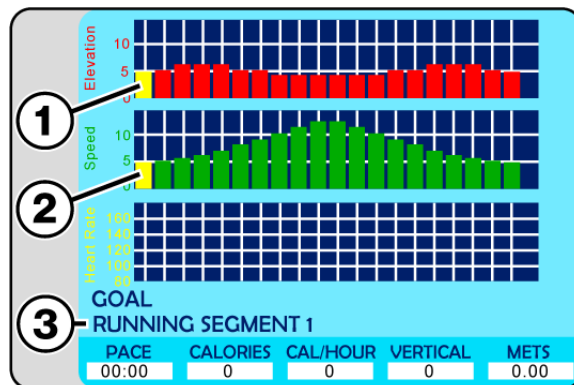

Goal Active Screen

As the program progresses, elevation and speed will adjust automatically for each segment, and the flashing yellow graph element will move along as the segments progress.

Note: Numeric buttons, CLEAR and ENTER buttons are deactivated while the program is running.

Pausing the Program

Pressing the PAUSE button pauses the statistics and the treadmill slows to a stop. The LCD displays “Paused Press Pause to Resume”.

Note: During Pause the CLEAR button is active allowing the user to clear/reset the statistics displayed at the bottom of the screen.

While the Goal program is running, the user can change incline, and speed using either the Up/Down, Fast/Slow buttons on the main control panel, or handrails.

Speed may also be adjusted using the numeric keypad by pressing the desired number and then the ENTER button.

When the program is completed, the LCD will read “Program Complete” and the SPEED will reset to zero. Pressing the OFF button will set the incline to zero and turn the LCD screen OFF.

Segment / Speed Overview (Goal Program)

The chart below offers a more specific speed parameter listing for each Effort Level and Segment during the workout.

		Segment																			
		1	2	3	4	5	6	7	8	9	10	11	12	13	14	15	16	17	18	19	20
Effort Level	1	0.5	0.5	0.6	0.7	0.7	0.8	0.9	1.0	1.1	1.2	1.2	1.1	1.0	0.9	0.8	0.7	0.6	0.6	0.5	0.5
	2	0.9	1.0	1.1	1.2	1.4	1.6	1.8	2.0	2.2	2.4	2.4	2.2	2.0	1.8	1.6	1.4	1.2	1.1	1.0	0.9
	3	1.4	1.5	1.7	1.8	2.1	2.4	2.7	3.0	3.3	3.6	3.6	3.3	3.0	2.7	2.4	2.1	1.8	1.7	1.5	1.4
	4	1.8	2.0	2.2	2.4	2.8	3.2	3.6	4.0	4.4	4.8	4.8	4.4	4.0	3.6	3.2	2.8	2.4	2.2	2.0	1.8
	5	2.3	2.5	2.8	3.0	3.5	4.0	4.5	5.0	5.5	6.0	6.0	5.5	5.0	4.5	4.0	3.5	3.0	2.8	2.5	2.3
	6	2.7	3.0	3.3	3.6	4.2	4.8	5.4	6.0	6.6	7.2	7.2	6.6	6.0	5.4	4.8	4.2	3.6	3.3	3.0	2.7
	7	3.2	3.5	3.9	4.2	4.9	5.6	6.3	7.0	7.7	8.4	8.4	7.7	7.0	6.3	5.6	4.9	4.2	3.9	3.5	3.2
	8	3.6	4.0	4.4	4.8	5.6	6.4	7.2	8.0	8.8	9.6	9.6	8.8	8.0	7.2	6.4	5.6	4.8	4.4	4.0	3.6
	9	4.1	4.5	5.0	5.4	6.3	7.2	8.1	9.0	9.9	10.8	10.8	9.9	9.0	8.1	7.2	6.3	5.4	5.0	4.5	4.1
	10	4.5	5.0	5.5	6.0	7.0	8.0	9.0	10.0	11.0	12.0	12.0	11.0	10.0	9.0	8.0	7.0	6.0	5.5	5.0	4.5

Speed Chart for Effort Levels and Segments

Speed / Incline Profile (Goal Program)

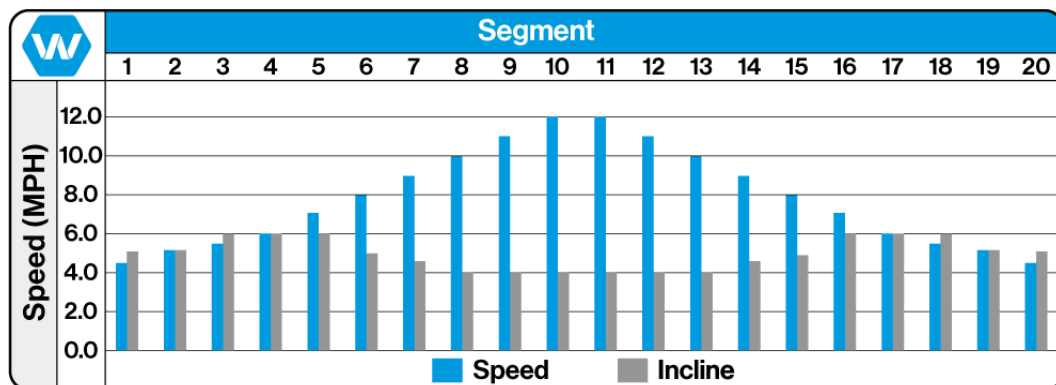

Goal Program Effort Level 10 Shown for Reference

10.7.3 Weight Loss Program

Designed to provide exercise at a constant level, this program utilizes a constant load and gradual warm-up and cool-down phases.

Select Weight Loss from the Fitness Programs menu screen and press the ENTER button.

The Weight Loss “Setup” screen will appear allowing the user to enter their preferences, and weight.

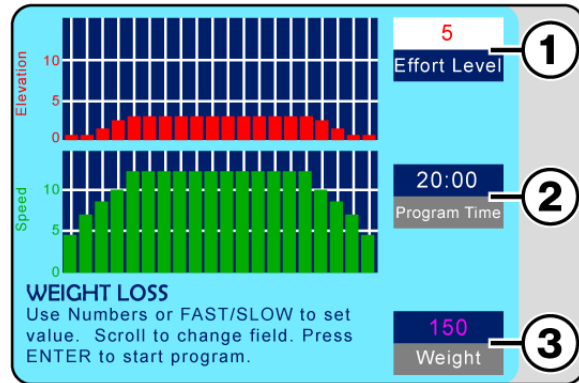

Weight Loss Setup Screen

Effort Level (1) There are 10 preprogrammed workouts, 1 = easiest / 10=hardest.

Program Time (2) Controls how long the workout will last (10-99 time range).

Weight (3) Allows users to enter their weight which is needed to properly track metrics during the workout.

NOTE: Do Not Press the ENTER button to set values, this will start the programmed workout.

Each time the arrow Up/Down button is pressed the previous value entered will be saved.

Use the Up/Down arrow buttons to scroll through the Input Panes the “Active” pane will display in **White (1)** (See Weight Loss Setup Screen).

Use the numeric keypad or Fast/Slow buttons to enter the desired value.

Scroll to the next pane and enter the desired value until all panes have the desired value.

To start the Program press the ENTER button. The display will change to “Active Mode” and the timer will start counting from the set value down to zero, while the speed and incline will set to the first preset **Segment Values (1/2)**.

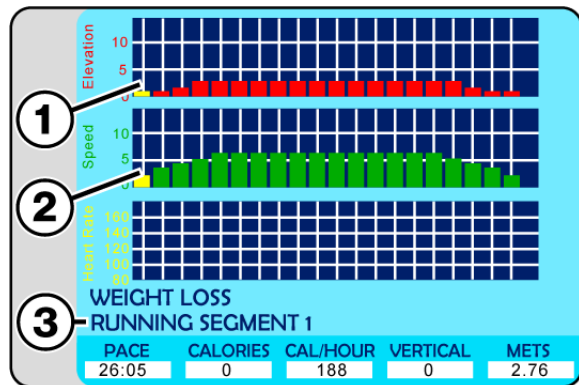

Weight Loss Active Screen

As the program progresses, elevation and speed will adjust automatically for each segment, and the flashing yellow graph element will move along as the segments progress.

Note: Numeric buttons, CLEAR and ENTER buttons are deactivated while the program is running.

Pausing the Program

Pressing the PAUSE button pauses the statistics and the treadmill slows to a stop. The LCD displays “Paused Press Pause to Resume”.

Note: During Pause the CLEAR button is active allowing the user to clear/reset the statistics displayed at the bottom of the screen.

While the Weight Loss program is running, the user can change incline, and speed using either the Up/Down, Fast/Slow buttons on the main control panel, or handrails.

Speed may also be adjusted using the numeric keypad by pressing the desired number and then the ENTER button.

When the program is completed, the LCD will read “Program Complete” and the SPEED will reset to zero. Pressing the OFF button will set the incline to zero and turn the LCD screen OFF.

Segment / Speed Overview (Weight Loss Program)

The Chart below offers a more specific speed parameter listing for each Effort Level and Segment during the workout.

W		Segment																			
		1	2	3	4	5	6	7	8	9	10	11	12	13	14	15	16	17	18	19	20
Effort Level	1	0.5	0.7	0.9	1.0	1.2	1.2	1.2	1.2	1.2	1.2	1.2	1.2	1.2	1.2	1.2	1.0	0.9	0.7	0.5	
	2	0.9	1.4	1.7	2.0	2.4	2.4	2.4	2.4	2.4	2.4	2.4	2.4	2.4	2.4	2.4	2.0	1.7	1.4	0.9	
	3	1.4	2.1	2.6	3.0	3.6	3.6	3.6	3.6	3.6	3.6	3.6	3.6	3.6	3.6	3.6	3.0	2.6	2.1	1.4	
	4	1.8	2.8	3.4	4.0	4.8	4.8	4.8	4.8	4.8	4.8	4.8	4.8	4.8	4.8	4.8	4.0	3.4	2.8	1.8	
	5	2.3	3.5	4.3	5.0	6.0	6.0	6.0	6.0	6.0	6.0	6.0	6.0	6.0	6.0	6.0	5.0	4.3	3.5	2.3	
	6	2.7	3.0	3.3	3.6	7.2	7.2	7.2	7.2	7.2	7.2	7.2	7.2	7.2	7.2	7.2	6.0	5.1	4.2	2.7	
	7	3.2	4.9	6.0	7.0	8.4	8.4	8.4	8.4	8.4	8.4	8.4	8.4	8.4	8.4	8.4	7.0	6.0	4.9	3.2	
	8	3.6	5.6	6.8	8.0	9.6	9.6	9.6	9.6	9.6	9.6	9.6	9.6	9.6	9.6	9.6	8.0	6.8	5.6	3.6	
	9	4.1	6.3	7.7	9.0	10.8	10.8	10.8	10.8	10.8	10.8	10.8	10.8	10.8	10.8	10.8	9.0	7.7	6.3	4.1	
	10	4.5	7.0	8.5	10.0	12.0	12.0	12.0	12.0	12.0	12.0	12.0	12.0	12.0	12.0	12.0	10.0	8.5	7.0	4.5	

Speed Chart for Effort Levels and Segments

Speed / Incline Profile (Weight Loss Program)

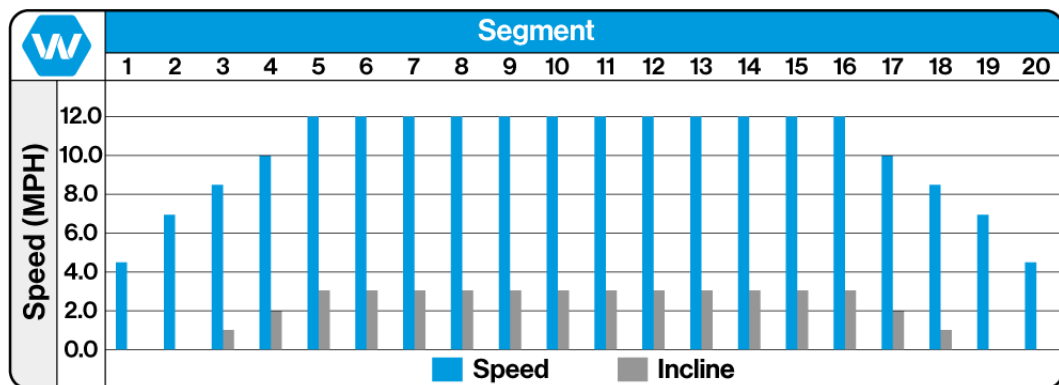

Weight loss Program Effort Level 10 Shown for Reference

10.7.4 Aerobic Program

Designed to improve the user’s aerobic condition, this program uses high-level training with 3 very intense phases.

Select Aerobic from the Fitness Programs menu screen and press the ENTER button.

The Aerobic “Setup” screen will appear allowing the user to enter their preferences, and weight.

Effort Level (1) There are 10 preprogrammed workouts, 1 = easiest / 10=hardest.

Program Time (2) Controls how long the workout will last (10-99 time range).

Weight (3) Allows users to enter their weight which is needed to properly track metrics during the workout.

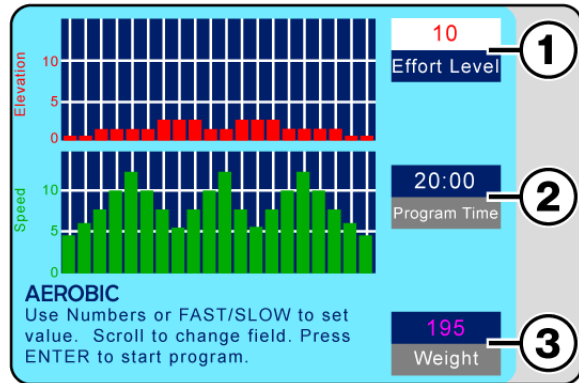

Aerobic Setup Screen

NOTE: Do Not Press the ENTER button to set values, this will start the programmed workout. Each time the arrow Up/Down button is pressed the previous value entered will be saved.

Use the Up/Down arrow buttons to scroll through the input panes the “Active” pane will display in **White (1)** (See Aerobic Setup Screen).

Use the numeric keypad or Fast/Slow buttons to enter the desired value.

Scroll to the next pane, and enter the desired value until all panes have the desired value.

To start the program, press the ENTER button. The display will change to “Active Mode” and the timer will start counting from the set value down to zero, while the speed and incline will set to the first preset **Segment Values (1/2)**.

Metrics begin accumulating, which are displayed in the lower portion of the screen. As the program starts the first segments will flash yellow, and the current **Segment Number (3)** will be displayed.

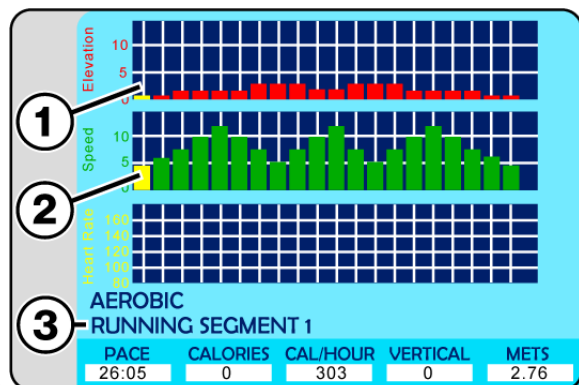

Aerobic Active Screen

As the program progresses, elevation and speed will adjust automatically for each segment, and the flashing yellow graph element will move along as the segments progress.

Note: Numeric buttons, CLEAR and ENTER buttons are deactivated while the program is running.

Pausing the Program

Pressing the PAUSE button pauses the statistics and the treadmill slows to a stop. The LCD displays “Paused Press Pause to Resume”.

Note: During Pause the CLEAR button is active allowing the user to clear/reset the statistics displayed at the bottom of the screen.

While the Aerobic program is running, the user can change incline, and speed using either the Up/Down, Fast/Slow buttons on the main control panel, or handrails. Speed may also be adjusted using the numeric keypad by pressing the desired number and then the ENTER button.

When the program is completed, the LCD will read “Program Complete” and the SPEED will reset to zero. Pressing the OFF button will set the incline to zero and turn the LCD screen OFF.

Segment / Speed Overview (Aerobic Program)

The Chart below offers a more specific speed parameter listing for each Effort Level and Segment during the workout.

		Segment																			
		1	2	3	4	5	6	7	8	9	10	11	12	13	14	15	16	17	18	19	20
Effort Level	1	0.5	0.6	0.8	1.0	1.2	1.0	0.8	0.6	0.8	1.0	1.2	0.8	0.6	0.8	1.0	1.2	1.0	0.8	0.6	0.5
	2	0.9	1.2	1.6	2.0	2.4	2.0	1.6	1.1	1.6	2.0	2.4	1.6	1.1	1.6	2.0	2.4	2.0	1.6	1.2	0.9
	3	1.4	1.8	2.4	3.0	3.6	3.0	2.4	1.7	2.4	3.0	3.6	2.4	1.7	2.4	3.0	3.6	3.0	2.6	1.8	1.4
	4	1.8	2.4	3.2	4.0	4.8	4.0	3.2	2.2	3.2	4.0	4.8	3.2	2.2	3.2	4.0	4.8	4.0	3.2	2.4	1.8
	5	2.3	3.0	4.0	5.0	6.0	5.0	4.0	2.8	4.0	5.0	6.0	4.0	2.8	4.0	5.0	6.0	5.0	4.0	3.0	2.3
	6	2.7	3.6	4.8	6.0	7.2	6.0	4.8	3.3	4.8	6.0	7.2	4.8	3.3	4.8	6.0	7.2	6.0	4.8	3.6	2.7
	7	3.2	4.2	5.6	7.0	8.4	7.0	5.6	3.9	5.6	7.0	8.4	5.6	3.9	5.6	7.0	8.4	7.0	5.6	4.2	3.2
	8	3.6	4.8	6.4	8.0	9.6	8.0	6.4	4.4	6.4	8.0	9.6	6.4	4.4	6.4	8.0	9.6	8.0	6.4	4.8	3.6
	9	4.1	5.4	7.2	9.0	10.8	9.0	7.2	5.0	7.2	9.0	10.8	7.2	5.0	7.2	9.0	10.8	9.0	7.2	5.4	4.1
	10	4.5	6.0	8.0	10.0	12.0	10.0	8.0	5.5	8.0	10.0	12.0	8.0	5.5	8.0	10.0	12.0	10.0	8.0	6.0	4.5

Speed Chart for Effort Levels and Segments

Speed / Incline Profile (Aerobic Program)

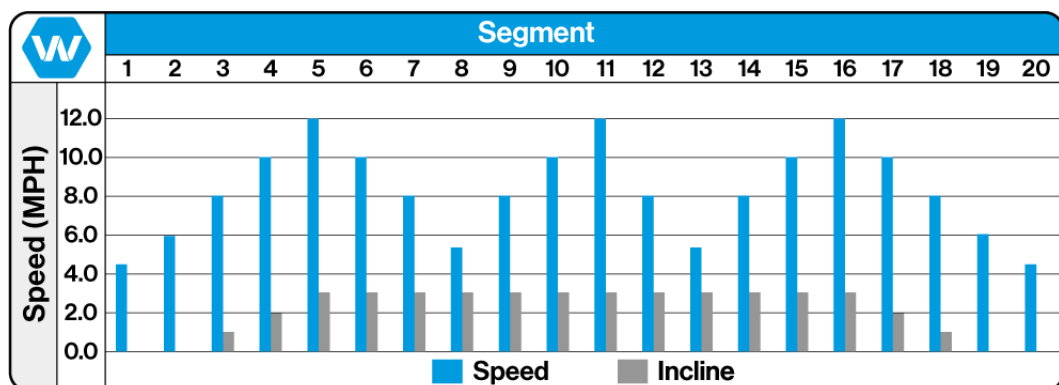

Aerobic Program Effort Level 10 Shown for Reference

10.7.5 Interval Program

Interval program allows the user to set 2 different interval modules that control the incline and speed, Once the values have been set and the program in running, the user can toggle between the 2 interval modules using the arrow scroll buttons to the right of the LCD screen.

Select Interval from the fitness programs menu screen, and press the ENTER button, the Interval "Setup" screen will appear allowing the user to enter the desired elevation and speed for each interval module, as well as the overall training time and their weight.

Use the Up/Down arrow buttons to scroll through the input panes the "Active" pane will display in **White (1)**.

Use the numeric keypad or Fast/Slow buttons to enter the desired value.

Scroll to the next pane and enter the desired value until all panes have the desired value.

NOTE: Do Not press the ENTER button to set values, this will start the interval workout session.

Each time an arrow Up/Down button is pressed the previous value entered will be saved.

To start the Program, press the ENTER button. The display will change to "Active Mode".

The timer will start counting from the set value down to zero and the Metrics begin accumulating, which are displayed in the lower portion of the screen, and the graphs will start to populate with progress bars.

At any time the user may use the Up/Down scroll buttons to the right of the LCD to toggle from one interval module to another.

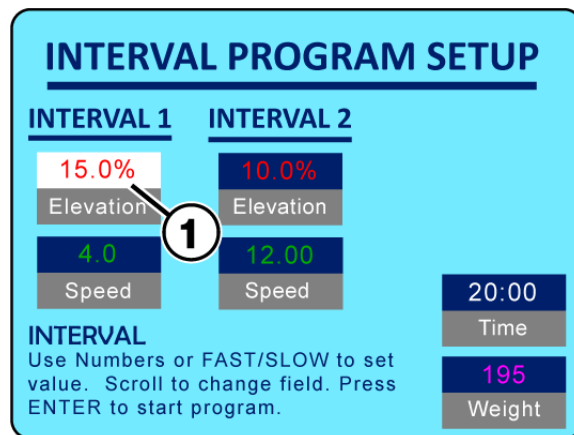

Interval Setup Screen

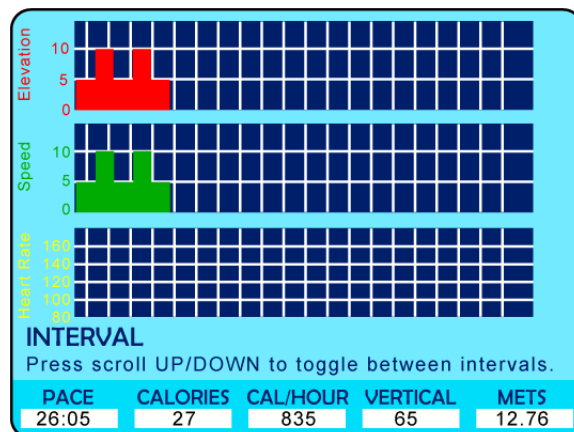

Interval Active Screen

Note: Numeric buttons, CLEAR and ENTER buttons are deactivated while the program is running.

Pausing the Program

Pressing the PAUSE button pauses the statistics and the treadmill slows to a stop. The LCD displays "Paused Press Pause to Resume".

Note: During Pause the CLEAR button is active allowing the user to clear/reset the statistics displayed at the bottom of the screen.

10.7.6 Random Program

The Random Program has ten different Effort Levels to choose from, all of which select varying speed and incline changes at random intervals.

Select Random from the Fitness Programs menu screen and press the ENTER button.

The Random “Setup” screen will appear allowing the user to enter their preferences, and weight.

Effort Level (1) There are 10 preprogrammed workouts, 1 = easiest / 10=hardest.

Program Time (2) Controls how long the workout will last (10-99 time range).

Weight (3) Allows users to enter their weight which is needed to properly track metrics during the workout.

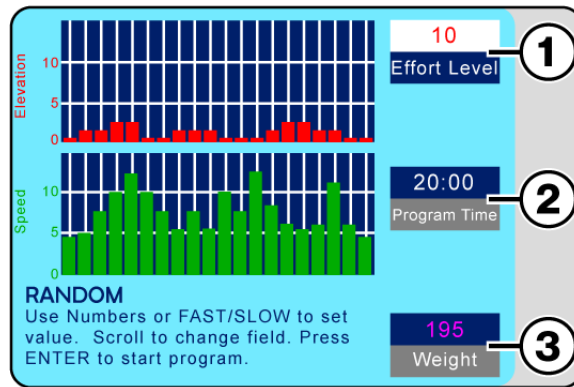

Random Setup Screen

NOTE: Do Not Press the ENTER button to set values, this will start the programmed workout.

Each time the Arrow Up/Down button is pressed the previous value entered will be saved.

Use the Up/Down arrow buttons to scroll through the input panes the “Active” pane will display in **White (1)**.

Use the numeric keypad or Fast/Slow buttons to enter the desired value.

Scroll to the next pane and enter the desired value until all panes have the desired value.

To start the program, press the ENTER button. The display will change to “Active Mode” and the timer will start counting from the set value down to zero, while the speed and incline will set to the first preset **Segment Values (1/2)**.

Metrics begin accumulating, which are displayed in the lower portion of the screen. As the program starts the first segments will flash yellow, and the current **Segment Number (3)** will be displayed.

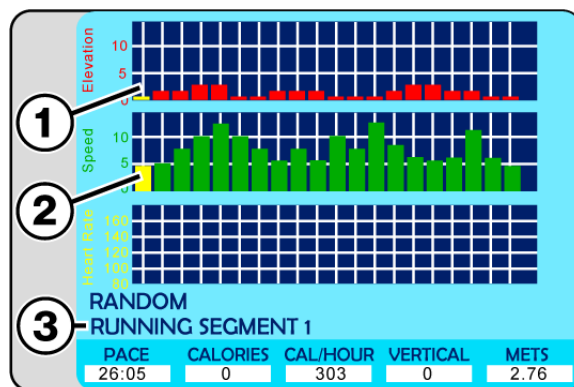

Random Active Screen

As the program progresses, elevation and speed will adjust automatically for each segment, and the flashing yellow graph element will move along as the segments progress.

Note: Numeric buttons, CLEAR and ENTER buttons are deactivated while the program is running.

Pausing the Program

Pressing the PAUSE button pauses the statistics and the treadmill slows to a stop. The LCD displays “Paused Press Pause to Resume”.

Note: During Pause the CLEAR button is active allowing the user to clear/reset the statistics displayed at the bottom of the screen.

While the Random program is running, the user can change incline, and speed using either the Up/Down, Fast/Slow buttons on the main control panel, or handrails.

Speed may also be adjusted using the numeric keypad by pressing the desired number and then the ENTER button.

When the program is completed, the LCD will read “Program Complete” and the SPEED will reset to zero. Pressing the OFF button will set the incline to zero and turn the LCD screen OFF.

Segment / Speed Overview (Random Program)

The Chart below offers a more specific speed parameter listing for each Effort Level and Segment during the workout.

		Segment																			
		1	2	3	4	5	6	7	8	9	10	11	12	13	14	15	16	17	18	19	20
Effort Level	1	0.4	0.5	0.8	0.8	0.6	0.9	1.1	0.6	0.8	0.6	1.9	0.7	1.2	0.8	0.6	0.6	0.8	1.1	0.6	0.5
	2	0.8	1.0	1.6	1.5	1.2	1.7	2.1	1.1	1.6	1.1	2.0	1.4	2.4	1.6	1.2	1.1	1.6	2.1	1.2	0.9
	3	1.2	1.5	2.4	2.3	1.8	2.6	3.2	1.7	2.4	1.7	3.0	2.1	3.6	2.4	1.8	1.7	2.4	3.2	1.8	1.4
	4	1.6	2.0	3.2	3.0	2.4	3.4	4.2	2.2	3.2	2.2	4.0	2.8	4.8	3.2	2.4	2.2	3.2	4.2	2.4	1.8
	5	2.0	2.5	4.0	3.8	3.0	4.3	5.3	2.8	4.0	2.8	5.0	3.5	6.0	4.0	3.0	2.8	4.0	5.3	3.0	2.3
	6	2.4	3.0	4.8	4.5	3.6	5.1	6.3	3.3	4.8	3.3	6.0	4.2	7.2	4.8	3.6	3.3	4.8	6.3	3.6	2.7
	7	2.8	3.5	5.6	5.3	4.2	6.0	7.4	3.9	5.6	3.9	7.0	4.9	8.4	5.6	4.2	3.9	5.6	7.4	4.2	3.2
	8	3.2	4.0	6.4	6.0	4.8	6.8	8.4	4.4	6.4	4.4	8.0	5.6	9.6	6.4	4.8	4.4	6.4	8.4	4.8	3.6
	9	3.6	4.5	7.2	6.8	5.4	7.7	9.5	5.0	7.2	5.0	9.0	6.3	10.8	7.2	5.4	5.0	7.2	9.5	5.4	4.1
	10	4.5	5.0	8.0	7.5	6.0	8.5	10.5	5.5	8.0	5.5	10.0	7.0	12.0	8.0	6.0	5.5	8.0	10.5	6.0	4.5

Speed Chart for Effort Levels and Segments

Speed / Incline Profile (Random Program)

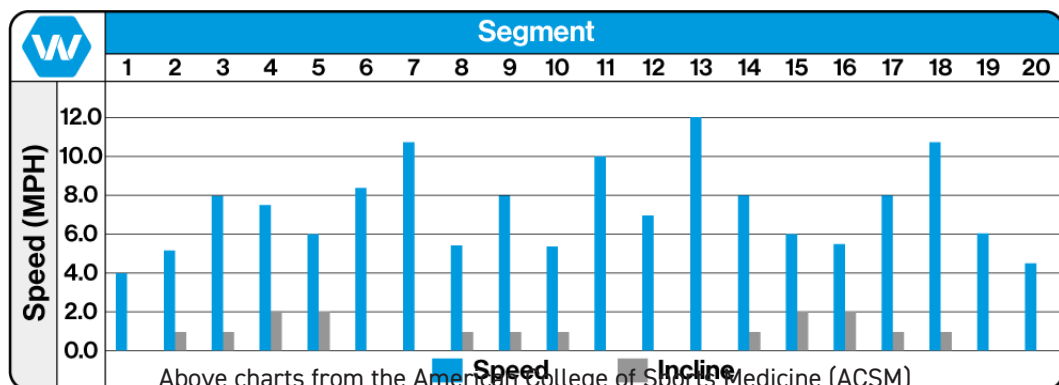

Above charts from the American College of Sports Medicine (ACSM)

Random Program Effort Level 10 Shown for Reference

10.7.7 Stamina Program

The program is intended for building endurance and stamina and is built upon an increasing load build up, with two different phases, each with a peak load to push the user.

Select Stamina from the Fitness Programs menu screen and press the ENTER button.

The Stamina "Setup" screen will appear allowing the user to enter their preferences, and weight.

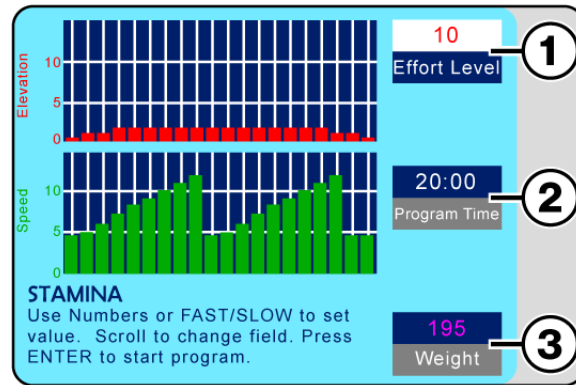

Stamina Setup Screen

Effort Level (1) There are 10 preprogrammed workouts, 1 = easiest / 10=hardest.

Program Time (2) Controls how long the workout will last (10-99 time range).

Weight (3) Allows user to enter their weight which is needed to properly track metrics during the workout.

NOTE: Do Not Press the ENTER button to set values, this will start the programmed workout.

Each time the Arrow Up/Down button is pressed the previous value entered will be saved.

Use the Up/Down arrow buttons to scroll through the input panes the "Active" pane will display in **White (1)**.

Use the numeric keypad or Fast/Slow buttons to enter the desired value.

Scroll to the next pane, and enter the desired value until all panes have the desired value.

To start the program, press the ENTER button. The display will change to "Active Mode" and the timer will start counting from the set value down to zero, while the speed and incline will set to the first preset **Segment Values (1/2)**.

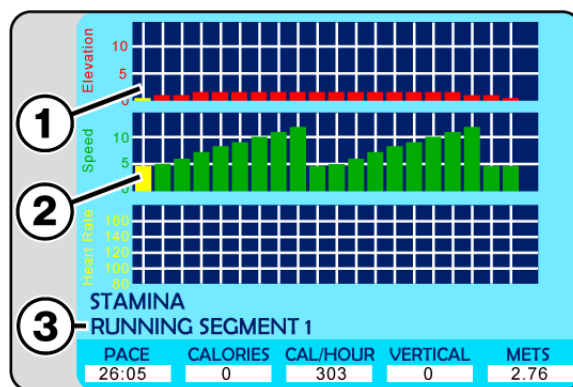

Stamina Active Screen

Metrics begin accumulating, which are displayed in the lower portion of the screen.

As the program starts the first segments will flash yellow, and the current **Segment Number (3)** will be displayed.

As the program progresses, elevation and speed will adjust automatically for each segment, and the flashing yellow graph element will move along as the segments progress.

Note: Numeric buttons, CLEAR and ENTER buttons are deactivated while the program is running.

Pausing the Program

Pressing the PAUSE button pauses the statistics and the treadmill slows to a stop. The LCD displays “Paused Press Pause to Resume”.

Note: During Pause the CLEAR button is active allowing the user to clear/reset the statistics displayed at the bottom of the screen.

While the Stamina program is running, the user can change incline, and speed using either the Up/Down, Fast/Slow buttons on the main control panel, or handrails.

Speed may also be adjusted using the numeric keypad by pressing the desired number and then the ENTER button.

When the program is completed, the LCD will read “Program Complete” and the SPEED will reset to zero. Pressing the OFF button will set the incline to zero and turn the LCD screen OFF.

Segment / Speed Overview (Stamina Program)

The Chart below offers a more specific speed parameter listing for each Effort Level and Segment during the workout.

		Segment																			
		1	2	3	4	5	6	7	8	9	10	11	12	13	14	15	16	17	18	19	20
Effort Level	1	0.5	0.5	0.6	0.7	0.8	0.9	1.0	1.1	1.2	0.5	0.5	0.6	0.7	0.8	0.9	1.0	1.1	1.2	0.5	0.5
	2	0.9	1.0	1.2	1.4	1.6	1.8	2.0	2.2	2.4	0.9	1.0	1.2	1.4	1.6	1.8	2.0	2.2	2.4	0.9	0.9
	3	1.4	1.5	1.8	2.1	2.4	2.7	3.0	3.3	3.6	1.4	1.5	1.8	2.1	2.4	2.7	3.0	3.3	1.4	1.4	1.4
	4	1.8	2.0	2.4	2.8	3.2	3.6	4.0	4.4	4.8	1.8	2.0	2.4	2.8	3.2	3.6	4.0	4.4	4.8	1.8	1.8
	5	2.3	2.5	3.0	3.5	4.0	4.5	5.0	5.5	6.0	2.3	2.5	3.0	3.5	4.0	4.5	5.0	5.5	6.0	2.3	2.3
	6	2.7	3.0	3.6	4.2	4.8	5.4	6.0	6.6	7.2	2.7	3.0	3.6	4.2	4.8	5.4	6.0	6.6	7.2	2.7	2.7
	7	3.2	3.5	4.2	4.9	5.6	6.3	7.0	7.7	8.4	3.2	3.5	4.2	4.9	5.6	6.3	7.0	7.7	8.4	3.2	3.2
	8	3.6	4.0	4.8	5.6	6.4	7.2	8.0	8.8	9.6	3.6	4.0	4.8	5.6	6.4	7.2	8.0	8.8	9.6	3.6	3.6
	9	4.1	4.5	5.4	6.3	7.2	8.1	9.0	9.9	10.8	4.1	4.5	5.4	6.3	7.2	8.1	9.0	9.9	10.8	4.1	4.1
	10	4.5	5.0	6.0	7.0	8.0	9.0	10.0	11.0	12.0	4.5	5.0	6.0	7.0	8.0	9.0	10.0	11.0	12.0	4.5	4.5

Speed Chart for Effort Levels and Segments

Speed / Incline Profile (Stamina Program)

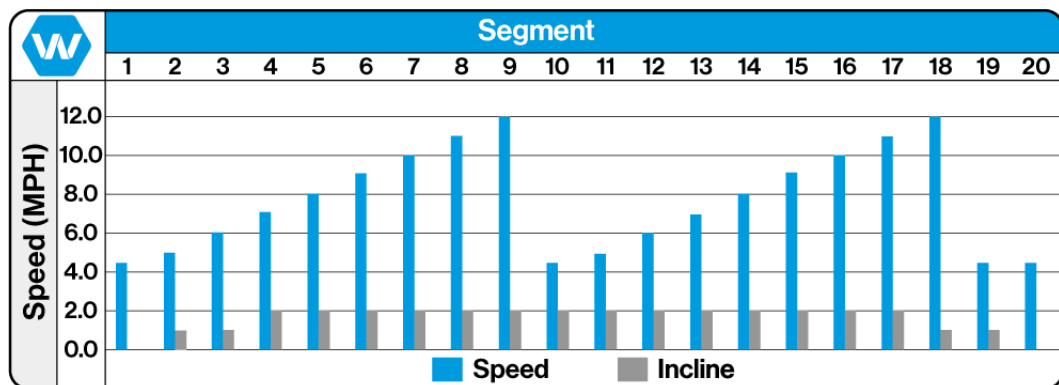

Stamina Program Effort Level 10 Shown for Reference

10.7.8 Ramp Program

The program is intended for building endurance and stamina and is built upon an increasing load build up, with two different phases, each with a peak load to push the user.

Select Ramp from the Fitness Programs menu screen and press the ENTER button. The Ramp "Setup" screen will appear allowing the user to enter their preferences, and weight.

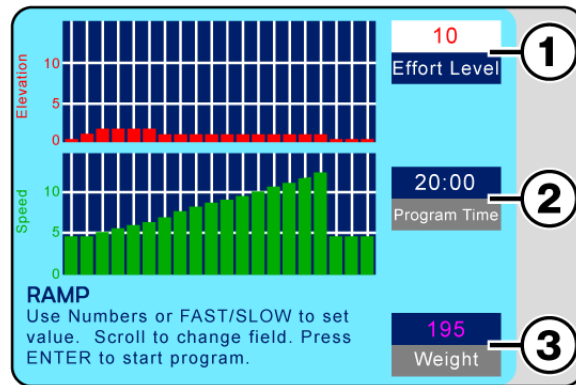

Ramp Setup Screen

Effort Level (1) There are 10 preprogrammed workouts, 1 = easiest / 10=hardest.

Program Time (2) Controls how long the workout will last (10-99 time range).

Weight (3) Allows users to enter their weight which is needed to properly track metrics during the workout.

NOTE: Do Not Press the ENTER button to set values, this will start the programmed workout.

Each time the arrow Up/Down button is pressed the previous value entered will be saved.

Use the Up/Down arrow buttons to scroll through the input panes the "Active" pane will display in **White (1)**.

Use the numeric keypad or Fast/Slow buttons to enter the desired value.

Scroll to the next pane and enter the desired value until all panes have the desired value.

To start the program, press the ENTER button. The display will change to "Active Mode" and the timer will start counting from the set value down to zero, while the speed and incline will set to the first preset **Segment Values (1/2)**.

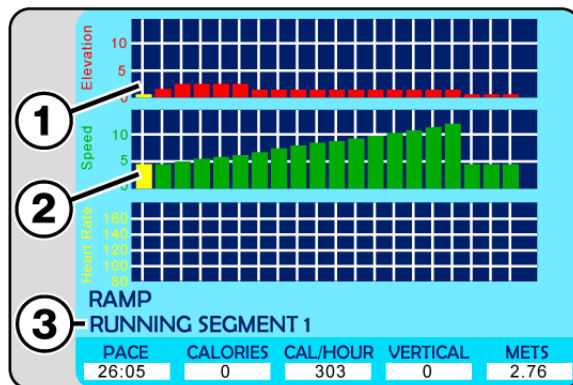

Ramp Active Screen

Metrics begin accumulating, which are displayed in the lower portion of the screen.

As the program starts the first segments will flash yellow, and the current **Segment Number (3)** will be displayed.

As the program progresses, the elevation and speed will adjust automatically for each segment, and the flashing yellow graph element will move along as the segments progress.

Note: Numeric buttons, CLEAR and ENTER buttons are deactivated while the program is running.

Pausing the Program

Pressing the PAUSE button pauses the statistics and the treadmill slows to a stop. The LCD displays “Paused Press Pause to Resume”.

Note: During Pause the CLEAR button is active allowing the user to clear/reset the statistics displayed at the bottom of the screen.

While the Ramp program is running, the user can change incline, and speed using either the Up/Down, Fast/Slow buttons on the main control panel, or handrails. Speed may also be adjusted using the numeric keypad by pressing the desired number and then the ENTER button.

When the program is completed, the LCD will read “Program Complete” and the SPEED will reset to zero. Pressing the OFF button will set the incline to zero and turn the LCD screen OFF.

Segment / Speed Overview (Ramp Program)

The Chart below offers a more specific speed parameter listing for each Effort Level and Segment during the workout.

W	Segment																				
	1	2	3	4	5	6	7	8	9	10	11	12	13	14	15	16	17	18	19	20	
Effort Level	1	0.5	0.5	0.5	0.6	0.6	0.7	0.7	0.8	0.8	0.9	0.9	1.0	1.0	1.1	1.1	1.2	1.2	0.5	0.5	0.5
	2	0.9	0.9	1.0	1.1	1.2	1.3	1.4	1.5	1.6	1.7	1.8	1.9	2.0	2.1	2.2	2.3	2.4	0.9	0.9	0.9
	3	1.4	1.4	1.5	1.7	1.8	2.0	2.1	2.3	2.4	2.6	2.7	2.9	3.0	3.2	3.3	3.5	3.6	1.4	1.4	1.4
	4	1.8	1.8	2.0	2.2	2.4	2.6	2.8	3.0	3.2	3.4	3.6	3.8	4.0	4.2	4.4	4.6	4.8	1.8	1.8	1.8
	5	2.3	2.3	2.5	2.8	3.0	3.3	3.5	3.8	4.0	4.3	4.6	4.8	5.0	5.3	5.5	5.8	6.0	2.3	2.3	2.3
	6	2.7	2.7	3.0	3.3	3.6	3.9	4.2	4.5	4.8	5.1	5.4	5.7	6.0	6.3	6.6	6.9	7.2	2.7	2.7	2.7
	7	3.2	3.2	3.5	3.9	4.2	4.6	4.9	5.3	5.5	6.0	6.3	6.7	7.0	7.4	7.7	8.1	8.4	3.2	3.2	3.2
	8	3.6	3.6	4.0	4.4	4.8	5.2	5.5	6.0	6.4	6.8	7.2	7.5	8.0	8.4	8.8	9.2	9.5	3.6	3.6	3.6
	9	4.1	4.1	4.5	5.0	5.4	5.9	6.3	6.8	7.2	7.7	8.1	8.8	9.0	9.6	9.9	10.4	10.8	4.1	4.1	4.1
	10	4.6	4.6	5.0	5.5	6.0	6.5	7.0	7.5	8.0	8.5	9.0	9.5	10.0	10.5	11.0	11.5	12.0	4.5	4.5	4.5

Speed Chart for Effort Levels and Segments

Speed / Incline Profile (Ramp Program)

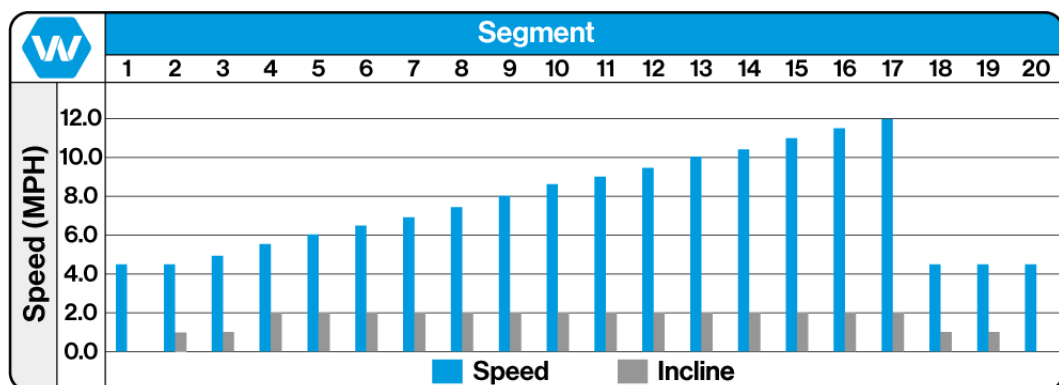

Ramp Program Effort Level 10 Shown for Reference

10.7.9 5 K Program

The 5 K program is a distance-based program with a simulated 5-kilometer (3.1 mile) race track. The user determines the running speed by selecting the effort level.

Note: Unlike other programs there is NO Program Time input, it is the users selected Effort Level that determines the pace and overall time.

Select 5 K from the Fitness Programs menu screen and press the ENTER button.

The 5 K “Setup” screen will appear allowing the user to enter their effort level, and weight.

Effort Level (1) There are 10 preprogrammed workouts, 1 = easiest / 10=hardest.

Weight (2) Allows users to enter their weight which is needed to properly track metrics during the workout.

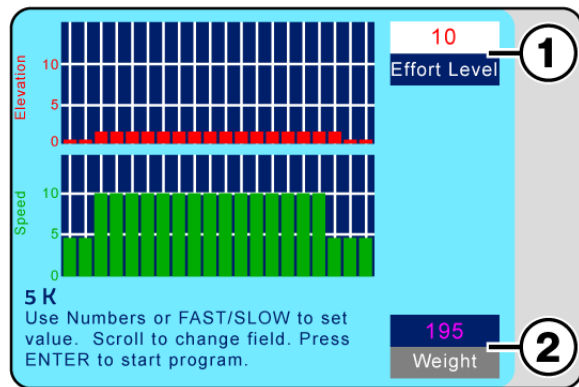

5 K Setup Screen

NOTE: Do Not Press the ENTER button to set values, this will start the programmed workout.

Each time the Arrow Up/Down button is pressed the previous value entered will be saved.

Use the Up/Down arrow buttons to scroll through the input panes the “Active” pane will display in **White (1)**.

Use the numeric keypad or Fast/Slow buttons to enter the desired value. Scroll to the next pane, and enter the desired value until all panes have the desired value.

To start the program, press the ENTER button.

The display will change to “Active Mode” and the timer will start counting from the set value down to zero, while the speed and incline will set to the first preset **Segment Values (1/2)**.

Metrics begin accumulating, which are displayed in the lower portion of the screen.

As the program starts the first segments will flash yellow, and the current **Segment Number (3)** will be displayed.

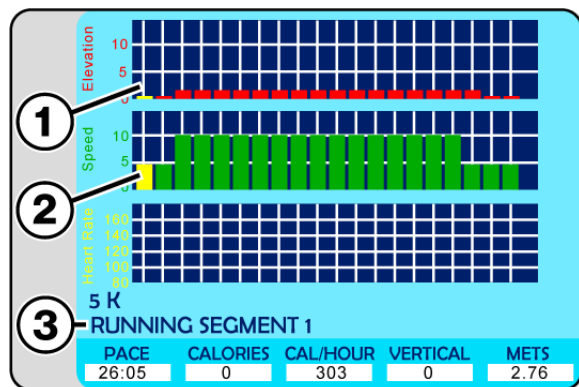

5 K Active Screen

As the program progresses, the elevation and speed will adjust automatically for each segment, and the flashing yellow graph element will move along as the segments progress.

Note: Numeric buttons, CLEAR and ENTER buttons are deactivated while the program is running.

Pausing the Program

Pressing the PAUSE button pauses the statistics and the treadmill slows to a stop. The LCD displays “Paused Press Pause to Resume”.

Note: During Pause the CLEAR button is active allowing the user to clear/reset the statistics displayed at the bottom of the screen.

While the 5 K program is running, the user can change incline, and speed using either the Up/Down, Fast/Slow buttons on the main control panel, or handrails.

Speed may also be adjusted using the numeric keypad by pressing the desired number and then the ENTER button.

When the program is completed, the LCD will read “Program Complete” and the SPEED will reset to zero. Pressing the OFF button will set the incline to zero and turn the LCD screen OFF.

Segment / Speed Overview (5 K Program)

The Chart below offers a more specific speed parameter listing for each Effort Level and Segment during the workout.

		Segment																			
		1	2	3	4	5	6	7	8	9	10	11	12	13	14	15	16	17	18	19	20
Effort Level	1	0.5	0.5	1.0	1.0	1.0	1.0	1.0	1.0	1.0	1.0	1.0	1.0	1.0	1.0	1.0	1.0	1.0	1.0	0.5	0.5
	2	0.9	0.9	2.0	2.0	2.0	2.0	2.0	2.0	2.0	2.0	2.0	2.0	2.0	2.0	2.0	2.0	2.0	2.0	0.9	0.9
	3	1.4	1.4	3.0	3.0	3.0	3.0	3.0	3.0	3.0	3.0	3.0	3.0	3.0	3.0	3.0	3.0	3.0	3.0	1.4	1.4
	4	1.8	1.8	4.0	4.0	4.0	4.0	4.0	4.0	4.0	4.0	4.0	4.0	4.0	4.0	4.0	4.0	4.0	4.0	1.8	1.8
	5	2.3	2.3	5.0	5.0	5.0	5.0	5.0	5.0	5.0	5.0	5.0	5.0	5.0	5.0	5.0	5.0	5.0	5.0	2.3	2.3
	6	2.7	2.7	6.0	6.0	6.0	6.0	6.0	6.0	6.0	6.0	6.0	6.0	6.0	6.0	6.0	6.0	6.0	6.0	2.7	2.7
	7	3.2	3.2	7.0	7.0	7.0	7.0	7.0	7.0	7.0	7.0	7.0	7.0	7.0	7.0	7.0	7.0	7.0	7.0	3.2	3.2
	8	3.6	3.6	8.0	8.0	8.0	8.0	8.0	8.0	8.0	8.0	8.0	8.0	8.0	8.0	8.0	8.0	8.0	8.0	3.6	3.6
	9	4.1	4.1	9.0	9.0	9.0	9.0	9.0	9.0	9.0	9.0	9.0	9.0	9.0	9.0	9.0	9.0	9.0	9.0	4.1	4.1
	10	4.5	4.5	10.0	10.0	10.0	10.0	10.0	10.0	10.0	10.0	10.0	10.0	10.0	10.0	10.0	10.0	10.0	10.0	4.5	4.5

Speed Chart for Effort Levels and Segments

Speed / Incline Profile (5 K Program)

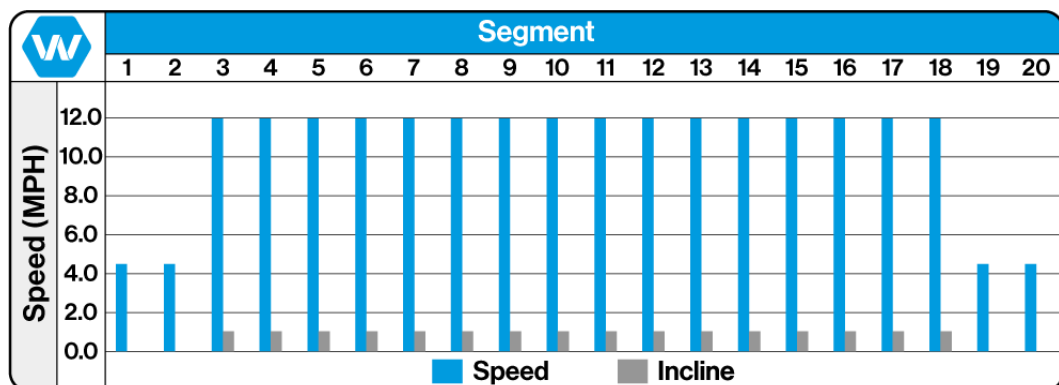

5 K Program Effort Level 10 Shown for Reference

10.7.10 10 K Program

The 10 K program is a distance-based program with a simulated 10-kilometer (6.2 mile) race track. The user determines the running speed by selecting the effort level.

Note: Unlike other programs there is NO Program Time input, it is the users selected Effort Level that determines the pace and overall time.

Select 10 K from the Fitness Programs menu screen and press the ENTER button.

The 10 K “Setup” screen will appear allowing the user to enter their effort level, and weight.

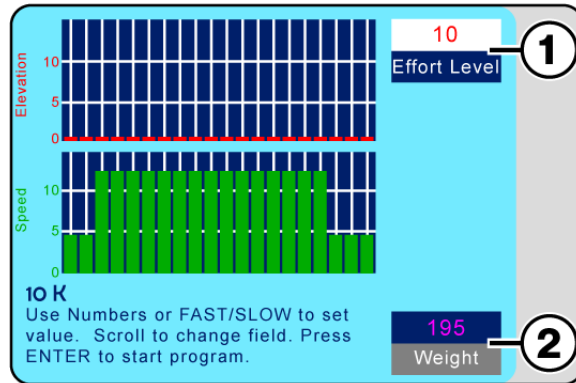

10 K Setup Screen

Effort Level (1) There are 10 preprogrammed workouts, 1 = easiest / 10=hardest.

Weight (2) Allows users to enter their weight which is needed to properly track metrics during the workout.

NOTE: Do Not Press the ENTER button to set values, this will start the programmed workout.

Each time the Arrow Up/Down button is pressed the previous value entered will be saved.

Use the Up/Down arrow buttons to scroll through the input panes the “Active” pane will display in **White (1)**.

Use the numeric keypad or Fast/Slow buttons to enter the desired value.

Then use the arrow buttons to scroll to the next pane and enter the desired value until all panes have the desired value.

To start the program, press the ENTER button. The display will change to “Active Mode” and the timer will start counting from the set value down to zero, while the speed and incline will set to the first preset **Segment Values (1/2)**.

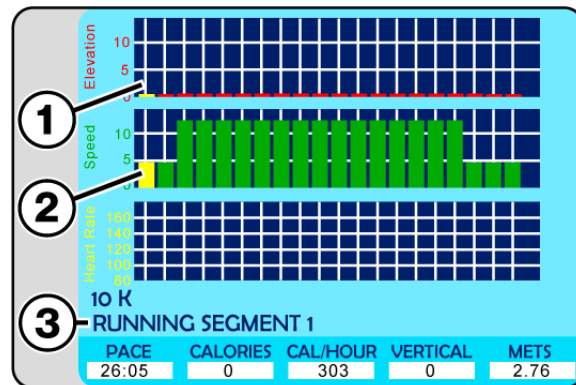

10 K Active Screen

Metrics begin accumulating, which are displayed in the lower portion of the screen.

As the program starts the first segments will flash yellow, and the current **Segment Number (3)** will be displayed.

As the program progresses, the elevation and speed will automatically adjust for each segment, and the flashing yellow graph element will move along as the segments progress.

Note: Numeric buttons, CLEAR and ENTER buttons are deactivated while the program is running.

Pausing the Program

Pressing the PAUSE button pauses the statistics and the treadmill slows to a stop. The LCD displays “Paused Press Pause to Resume”.

Note: During Pause the CLEAR button is active allowing the user to clear/reset the statistics displayed at the bottom of the screen.

While the 10 K program is running, the user can change incline, and speed using either the Up/Down, Fast/Slow buttons on the main control panel, or handrails.

Speed may also be adjusted using the numeric keypad by pressing the desired number and then the ENTER button.

When the program is completed, the LCD will read “Program Complete” and the SPEED will reset to zero. Pressing the OFF button will set the incline to zero and turn the LCD screen OFF.

Segment / Speed Overview (10 K Program)

The Chart below offers a more specific speed parameter listing for each Effort Level and Segment during the workout.

		Segment																			
		1	2	3	4	5	6	7	8	9	10	11	12	13	14	15	16	17	18	19	20
Effort Level	1	0.5	0.5	1.2	1.2	1.2	1.2	1.2	1.2	1.2	1.2	1.2	1.2	1.2	1.2	1.2	1.2	1.2	0.5	0.5	
	2	0.9	0.9	2.4	2.4	2.4	2.4	2.4	2.4	2.4	2.4	2.4	2.4	2.4	2.4	2.4	2.4	2.4	0.9	0.9	
	3	1.4	1.4	3.6	3.6	3.6	3.6	3.6	3.6	3.6	3.6	3.6	3.6	3.6	3.6	3.6	3.6	3.6	1.4	1.4	
	4	1.8	1.8	4.8	4.8	4.8	4.8	4.8	4.8	4.8	4.8	4.8	4.8	4.8	4.8	4.8	4.8	4.8	1.8	1.8	
	5	2.3	2.3	6.0	6.0	6.0	6.0	6.0	6.0	6.0	6.0	6.0	6.0	6.0	6.0	6.0	6.0	6.0	2.3	2.3	
	6	2.7	2.7	7.2	7.2	7.2	7.2	7.2	7.2	7.2	7.2	7.2	7.2	7.2	7.2	7.2	7.2	7.2	2.7	2.7	
	7	3.2	3.2	8.4	8.4	8.4	8.4	8.4	8.4	8.4	8.4	8.4	8.4	8.4	8.4	8.4	8.4	8.4	3.2	3.2	
	8	3.6	3.6	9.6	9.6	9.6	9.6	9.6	9.6	9.6	9.6	9.6	9.6	9.6	9.6	9.6	9.6	9.6	3.6	3.6	
	9	4.1	4.1	10.8	10.8	10.8	10.8	10.8	10.8	10.8	10.8	10.8	10.8	10.8	10.8	10.8	10.8	10.8	4.1	4.1	
	10	4.5	4.5	12.0	12.0	12.0	12.0	12.0	12.0	12.0	12.0	12.0	12.0	12.0	12.0	12.0	12.0	12.0	4.5	4.5	

Speed Chart for Effort Levels and Segments

Speed / Incline Profile (10 K Program)

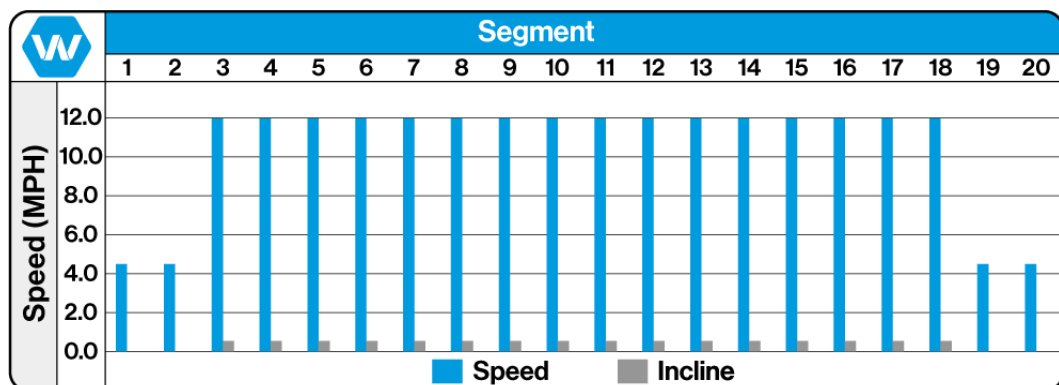

10 K Program Effort Level 10 Shown for Reference

10.7.11 User Programs

User Programs gives the ability to create and save up to 99 custom workouts with speed, time and incline settings all determined by the user.

For each program the user will create specific settings for each "Segment" (40 segments total per program) for the workout with specific speed, incline settings and time for each, (which will determine the overall workout time duration).

Programs can be given a specific custom name (up to 24 characters) programs may also be edited/modified and renamed at any time.

Creating a User Program

Select User Programs from the Fitness Programs menu screen and press the ENTER button.

The Programmed Workout list screen will appear.

Use the Up/Down arrow scroll buttons to select the desired program to name and create.

Note: If there have been no programs created or named the screen will display as shown to the right with just a list of "User Program #'s"

Naming the Program

With the desired program highlighted, press and hold the PAUSE button for 5 seconds to activate the text edit mode.

The highlighted selection will display in green with a red segment where the active cursor is, use the Up/Down incline buttons to scroll from right to left.

Use the Fast /Slow buttons to scroll through the alpha-numeric selections.

Once the Name has been created, press the ENTER button and the Program Setup screen will display.

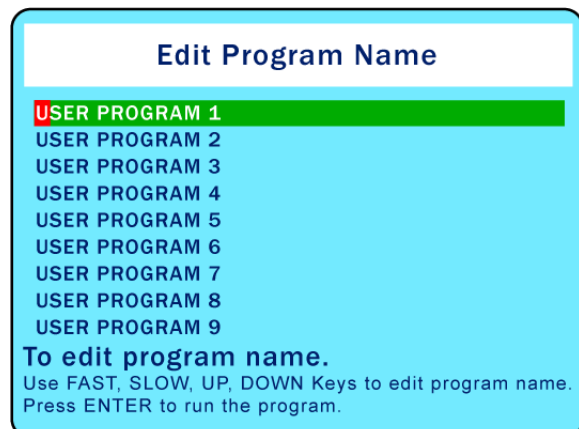
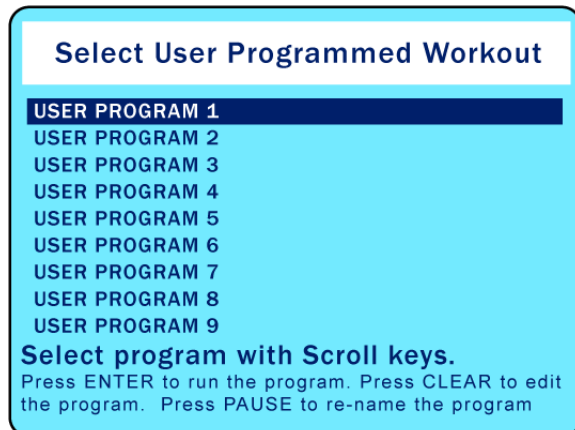

Creating a Custom Program

Much like the Setup screens for programmed workouts, the User Program screens allow the input for Elevation, Speed, Time, and Segments.

Use the Up/Down arrow buttons to scroll through the input panes the “Active” pane will display in white.

Use the numeric keypad or Fast/Slow buttons to enter the desired value in each pane until all panes have the desired value.

Each time the arrow Up/Down button is pressed the previous value entered will be saved.

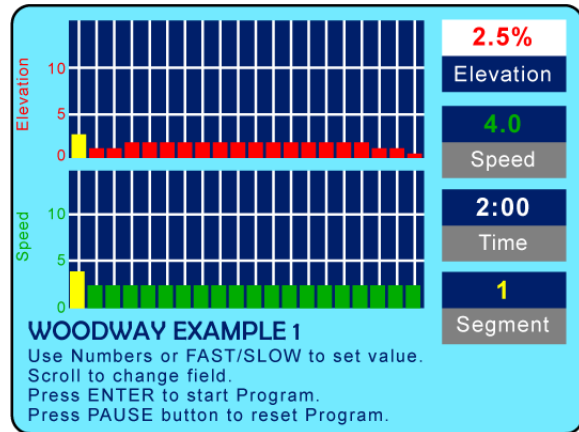

User Program Setup Screen

NOTE: Do Not Press the ENTER button to set values, this will start the programmed workout

Programing Segments

When the Setup screen is initially opened the **First Segments (1)** will be highlighted in yellow denoting them as the “Current Active” segment.

Select segments by highlighting the **Segment Pane (2)** and change the number to the desired pane.

Note: Segments must be programmed in sequential order, Do Not skip a segment.

Within each segment the user may select specific Elevations, Speeds, and Time/Duration.

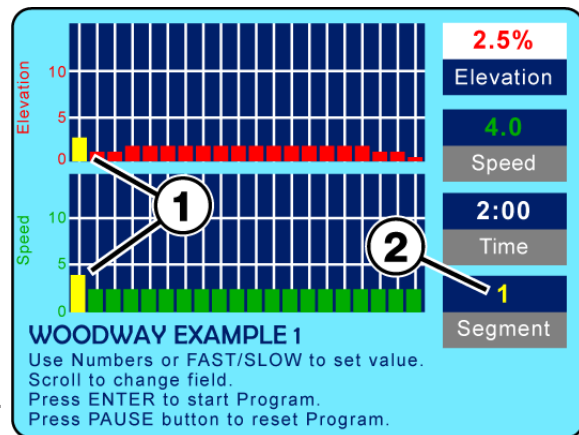

User Program Setup Screen

Understanding Segments

In “Standard Preprogrammed” routines the graph display is broken down into twenty specific segments, the duration of those segments is determined by the overall time set for the workout.

If the workout time is set for twenty minutes, each segment will last for 1 minute, if the workout time is set to forty minutes each segment will be 2 minutes long. etc....

Whatever the overall workout time is set to, the segments will be divided evenly in the allotted time frame.

In “User Defined Programs” each of the segments can be given a specific time/duration, so each segment will run for the programmed time, and the accumulative of all segment times will determine the overall length of the workout.

Programming Continued:

Shown to the right is an example of an **“Extended” Time Segment (1)** the graph will adjust and display the visual based on the time settings (the longer the time, the longer the segment will show) and number of segments in the overall program.

Segment Six is shown as the current active segment set for programming, so the sixth segment in the graphs will display in yellow.

When all desired segments have been programmed, press the ENTER button, and the program will be saved.

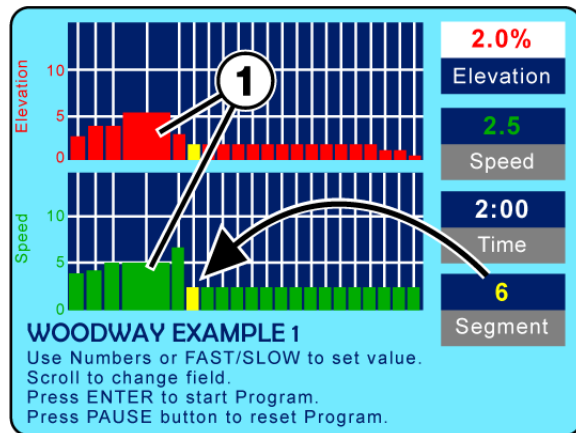

User Program Setup Screen

If there is no need for all forty segments to be programmed the user can select the unused segments and set the Elevation, Speed, and Time to 0.

After “clearing” the final unused segments, press the ENTER button and the program will be saved.

Clear an Entire Program

To clear an entire program and start a new program, press the PAUSE button while the User Program setup screen is active.

All forty segments will be cleared, and the screen will display “Program has Zero Time”.

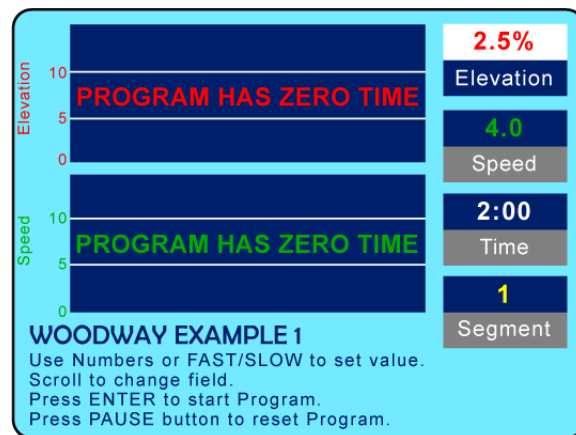

User Program Setup Screen

Starting a User Program

Select User Programs from the Fitness Programs menu screen and press the ENTER button.

Use the scroll arrow buttons to select the desired program and press the ENTER button.

Enter the user’s weight in the lower right pane using the numeric keypad and press the ENTER button to start the program.

As the program starts the first segments will flash yellow, as the program progresses the elevation and speed will automatically adjust for each segment, and the flashing yellow graph element will move along as the segments progress.

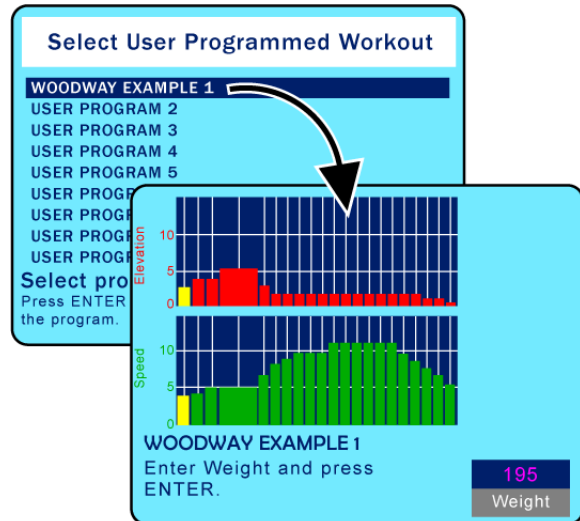

Note: Numeric buttons, CLEAR and ENTER buttons are deactivated while the program is running.

Pausing the Program

Pressing the PAUSE button pauses the statistics and the treadmill slows to a stop. The LCD displays “Paused Press Pause to Resume”.

Note: During Pause the CLEAR button is active allowing the user to clear/reset the statistics displayed at the bottom of the screen.

While the User Program is running, the user can change incline, and speed using either the Up/Down, Fast/Slow buttons on the main control panel, or handrails.

Speed may also be adjusted using the numeric keypad by pressing the desired number and then the ENTER button.

When the program is completed, the LCD will read “Program Complete” and the SPEED will reset to zero. Pressing the OFF button will set the incline to zero and turn the LCD screen OFF.

10.8 Fitness Tests

10.8.1 Balke Program

Developed to determine the user's current fitness level using the Balke protocol, this program evaluates the functional aerobic capacity (VO₂max), with which the cardio-respiratory fitness of the user is determined.

Under an increasing load, the oxygen consumption (VO₂) eventually reaches a plateau. This is the desired maximum VO₂ value.

Select Balke from the fitness test menu screen, set the values for age and sex using the number buttons or the Fast/Slow buttons.

Scroll to change fields.

Press ENTER to start the program.

Note: A heart rate chest strap is required for this test.

Note: Manually changing the speed or incline will make the test invalid.

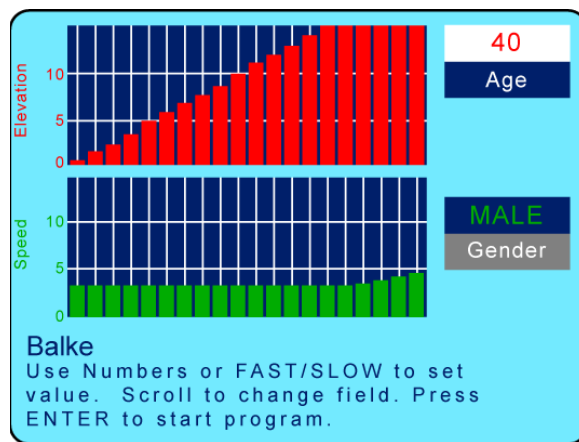

The test is terminated when the user's heart rate stabilizes at 130 BPM or at 80% of the user's maximum heart rate (whichever value is lower). Press the FAST speed key once to begin.

The time is automatically set to 20 minutes since the program has 20 program parts. Although the test is terminated earlier.

With this protocol the speed remains constant at 3.4 MPH (5.5 km/h).

The incline in the first minute is 0% and in the second minute 2%. With each following minute the incline increases by 1%.

A fitness value is displayed on the LCD screen (Fitness Value = VO2max value) tables below are organized by gender and age to show fitness level on a grade from Low to High.

		Balke Program - Mens Chart						
		10-19 yrs	20-29 yrs	30-39 yrs	40-49 yrs	50-59 yrs	60-69 yrs	70-79 yrs
VO2 Value	High	56+	53+	49+	45+	43+	41+	39+
	Good	46-55	43-52	39-48	36-44	34-42	31-40	29-38
	Average	36-45	34-42	31-38	27-35	25-33	23-30	21-28
	Adequate	27-35	25-33	23-30	20-26	18-24	16-22	14-20
	Low	27	25	23	20	18	16	14

		Balke Program - Womens Chart						
		10-19 yrs	20-29 yrs	30-39 yrs	40-49 yrs	50-59 yrs	60-69 yrs	70-79 yrs
VO2 Value	High	53+	49+	45+	42+	38+	35+	33+
	Good	41-52	38-48	34-44	31-41	28-37	24-34	22-32
	Average	33-40	31-37	28-33	24-30	21-27	18-23	15-21
	Adequate	27-32	24-30	20-27	17-23	15-20	13-17	11-14
	Low	27	24	20	17	15	13	11

10.8.2 Gerkin Program

The Gerkin protocol is a tiered VO2 test with sub-maximal values.

It is used by the International Association of Fire Fighters to determine fitness for service with the fire department.

Select Gerkin from the fitness test menu screen and set the values for age and gender using the number buttons or the Fast/Slow buttons.

Scroll to change fields. Press ENTER to start the program.

Note: Manually changing the speed or incline will make the test invalid.

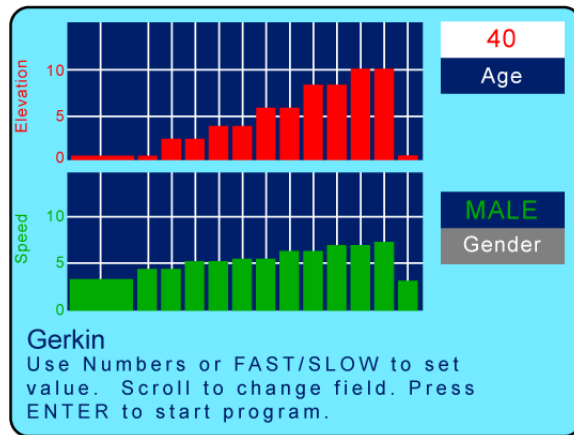

This test calculates the user's fitness when the heart rate stabilizes at ____ BPM and the program terminates.

Press FAST to start.

Y6
CAUTION

IF AT ANY TIME DURING A TEST THE USER EXPERIENCES CHEST PAIN, DIZZINESS, ATAXIA, CONFUSION, NAUSEA, OR COLD SWEAT, END THE TEST IMMEDIATELY!

- Place the heart rate chest strap device on the user.
- The user's heart rate is to be measured continuously throughout the test and in the cool-down phase. The heart rate is retrieved and recorded during the last 15 seconds of each phase.
- If the heart rate of the person exceeds the target training heart rate, continue the test in the phase in which the target training heart rate was exceeded for an additional 15 seconds.
- The test is completed, and the final testing phase is given if the heart rate does not return to the target training heart rate (or a lower value) or when the person reaches phase 11.4.
- The VO2max is determined using the heart rate retrieved during the final test phase and the conversion table.
- Record the heart rate after a one-minute cool-down.

Fitness Test Protocol Worksheet

Name: _____

Resting Heart Rate: _____ Trial 1: _____ Trial 2: _____ Trail 3: _____

Blood Pressure: _____ Trial 1: _____ Trial 2: _____ Trail 3: _____

Weight: _____ lbs. kg. Training Heart Rate (85% of HR max) _____

Gerkin Phase Chart				
Phase	Minute	Speed (MPH)	Incline (%)	Heart Rate (last 15 seconds of the phase)
Warm-Up	3 Minutes	3.0	0	
1	1	4.5	0	
2	2	4.5	2	
3	3	5.0	2	
4	4	5.0	4	
5	5	5.5	4	
6	6	5.5	6	
7	7	6.0	6	
8	8	6.0	8	
9	9	6.5	8	
10	10	6.5	10	
11	11	7.0	10	
Cool-Down	1 Minute	3.0	0	

Gerkin Phase Chart		
Phase	Time	Calculated VO2max
1	1:00	31:15
2.1	1:15	32:55
2.2	1:30	33:6
2.3	1:45	34:65
2.3	2:00	35:35
3.1	2:15	37:45
3.2	2:30	39:55
3.3	2:45	41:30
3.4	3:00	43:4
4.1	3:15	44:1
4.2	3:30	45:15
4.3	3:45	46:2
4.4	4:00	46:5
5.1	4:15	48:6
5.2	4:30	50
5.3	4:45	51:4
5.4	5:00	52:8
6.1	5:15	53:9
6.2	5:30	54:9
6.3	5:45	56
6.4	6:00	57
7.1	6:15	57:7
7.2	6:30	58:8
7.3	6:45	60:2
7.4	7:00	61:2
8.1	7:15	62:3
8.2	7:30	63:3
8.3	7:45	64
8.4	8:00	65
9.1	8:15	66:5
9.2	8:30	68:2
9.3	8:45	69
9.4	9:00	70:7
10.1	9:15	71:1
10.2	9:30	73:1
10.3	9:45	73:8
10.4	10:00	74:9
11.1	10:15	76:3
11.2	10:30	77:7
11.3	10:45	79:1
11.4	10:00	80

10.8.3 Copper Program

Set the values for your age and gender using the number keys or the FAST/SLOW keys. Scroll to change fields.

Press ENTER to start the program. Run as far as you can in 12 minutes.

Note: To achieve optimal results the Speed must be manually set by the user at the fastest speed they are comfortable with.

The Program does not set the speed. Leave the incline at 0%.

The test is to find out how far an athlete can run/walk in 12 minutes.

The assistant should round the results off to the nearest 100 meters.

The table below shows standard data for the Cooper test:

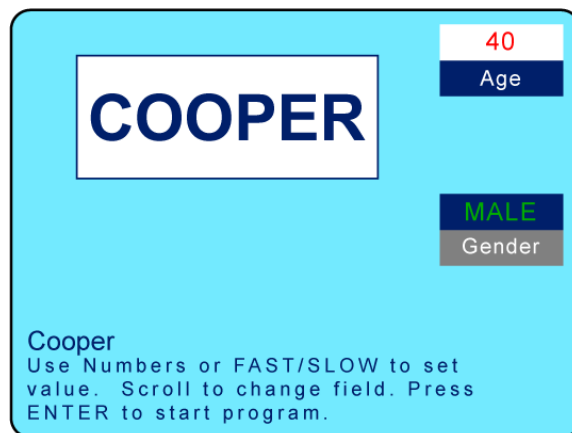

Cooper Program					
Age	Outstanding	Above Average	Average	Below Average	Low
Male 13-14	>2700 m	2400-2700 m	2200-2399 m	2100-2199 m	<2100 m
Female 13-14	>2000 m	1900-2000 m	1600-1899 m	1500-1599 m	<1500 m
Male 15-16	>2800 m	2500-2800 m	2300-2499 m	2200-2299 m	<2200 m
Female 15-16	>2100 m	2000-2100 m	1700-1999 m	1600-1699 m	<1600 m
Male 17-20	>3000 m	2700-3000 m	2500-2699 m	2300-2499 m	<2300 m
Female 17-20	>2300 m	2100-2300 m	1800-2099 m	1700-1799 m	<1700 m
Male 20-29	>2800 m	2400-2800 m	2200-2399 m	1600-2199 m	<1600 m
Female 20-29	>2700 m	2200-2700 m	1800-2199 m	1500-1799 m	<1500 m
Male 30-39	>2700 m	2300-2700 m	1900-2299 m	1500-1999 m	<1500 m
Female 30-39	>2500 m	2000-2500 m	1700-1999 m	1400-1699 m	<1400 m
Male 40-49	>2500 m	2100-2500 m	1700-2099 m	1400-1699 m	<1400 m
Female 40-49	>2300 m	1900-2300 m	1500-1899 m	1200-1499 m	<1200 m
Male > 50	>2400 m	2000-2400 m	1600-1999 m	1300-1599 m	<1300 m
Female > 50	>2200 m	1700-2200 m	1400-1699 m	1100-1399 m	<1100 m

10.8.4 Rockport Program

Set the values for your age and gender using the number keys or the Fast/Slow keys.

Scroll to change fields. Press ENTER to start the program.

Walk 1 mile (1609 m) as fast as you can.

Note: To achieve optimal results the Speed must be manually set by the user at the fastest speed they are comfortable with. The Program does not set the speed. Leave the incline at 0%.

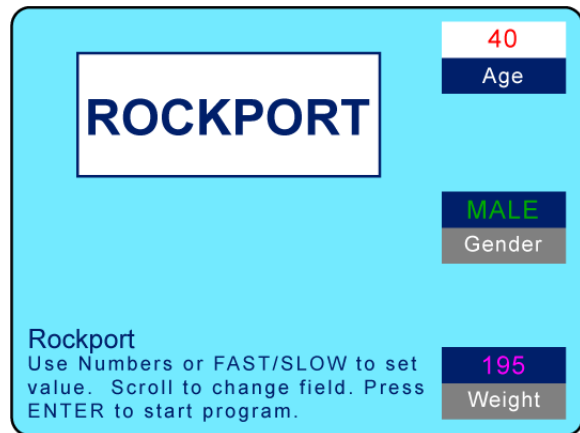

Note: You must wear a heart rate chest strap or hold the sensor grips for this test.

- Record your weight.
- Walk 1 mile (1609 m) as fast as possible.
- Record your time to complete the 1 mile (1609 m).
- Record your heart rate after finishing the walk (BPM).
- Determine your V02max value using the formula below.

Analyze Results:

- The analysis of the results is to compare the results with the results of previous test trials. It can be expected that, with appropriate training, improvement will be seen between trials.
- The formula for the calculation of V02max value is as follows:
- $132.853 - (0.0769 \times \text{Weight}) - (0.3877 \times \text{Age}) + (6.315 \times \text{Gender}) - (3.2649 \times \text{Time}) - (0.1565 \times \text{Heart rate})$

The Following Apply:

- Weight: Record in pounds (lbs.)
- Gender: Female records "0" and male records "1"
- Time: Minutes and hundredths of minutes
- Heart rate: Beats per minute (BPM)
- Age: Years

Female				Male			
Age	High	Average	Low	Age	High	Average	Low
18-21	>45.3	42.7-41.0	< 39.4	18-21	>56.1	52.4-54.1	< 49.8
20-29	>40.9	36.7-33.8	< 30.6	20-29	>48.2	44.2-41.0	< 37.1
30-39	>38.6	34.6-32.3	< 28.7	30-39	>46.8	42.4-38.9	< 35.4
40-49	>36.3	32.3-29.5	< 26.5	40-49	>44.1	39.9-36.7	< 33.0
50-59	>32.3	29.4-26.9	< 24.3	50-59	>41.0	36.7-33.5	< 30.2
60+	>31.2	27.2-24.5	< 22.8	60+	>38.1	33.6-30.2	< 26.5

10.9 Military Test Programs

The Military Test programs provide workouts of a preset distance, as required by the Army, Navy, USMC, and USAF. They are used to assess muscular endurance and cardio-respiratory fitness.

As the names imply, the object of each test is to complete the run distance as quickly as possible. At the completion of the test, a time-based score (defined by the respective branch of the Military) is returned to the user. Each test begins with a treadmill incline of 1% (best simulates outdoor running).

Army Program

Select Army from the Fitness test menu screen and press the ENTER button. Using the number keys or Fast/Slow buttons, set your age and gender values.

Scroll to change between fields. Press ENTER to start the program. Run as fast as you can for 2 miles (3.2 km).

For the best score, you must adjust your speed during the test.

Leave incline at 0%.

Press FAST to start.

The scoring standards can be found on-line:
<http://army.com/info/apft/twomileruntable>

Air Force & Navy Programs

Select Air Force or Navy from the Fitness test menu screen and press the ENTER button.

Using the number keys or Fast/Slow buttons, set your age and gender values.

Scroll to change between fields.

Press ENTER to start the program.

Run as fast as you can for 1.5 miles (2.4 km).

For the best score, you must adjust your speed during the test. Set the incline to 1.0%. Press FAST to start.

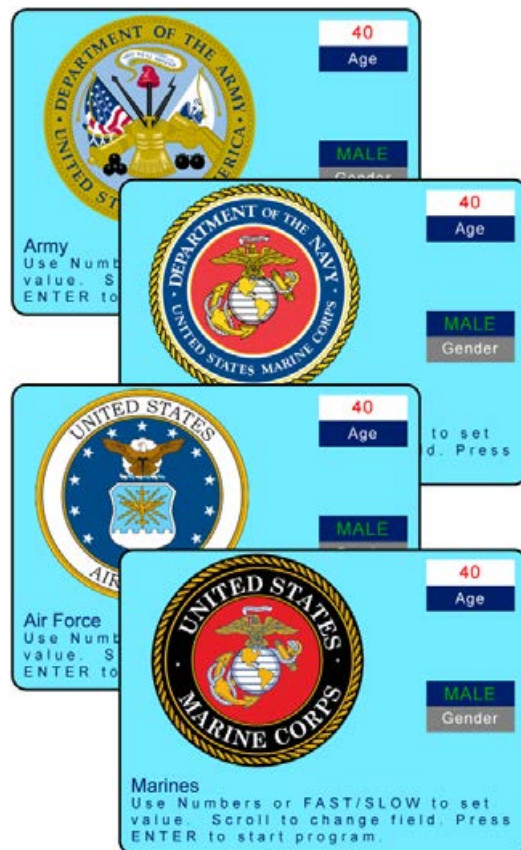

The scoring standards can be found on-line:

<http://www.afpc.af.mil/shared/media/document/AFD-110804-054.pdf> (USAF)

<http://www.uscg.mil/sapr/docs/pdf/Fitness%20Assessment%203-28-.pdf> (USCG),

http://www.public.navy.mil/bupers-npc/support/21st_Century_Sailor/physical/Documents/Guide%205-Physical%20Readiness%20Test.pdf (USN)

Note: Air Force Program, Coast Guard Pro-gram, and Navy Program differ only in the way the results are given; Air Force results are given in a point system.

Marines Program

Select Marines from the Fitness test menu screen and press the ENTER button.

Using the number keys or Fast/Slow buttons, set your age and gender values.

Scroll to change between fields.

Press ENTER to start the program. Run as fast as you can for 3 miles (4.8 km).

For the best score, you must adjust your speed during the test.

Leave incline at 0%. Press FAST to start. You can find the scoring standards online:

http://www.marines.mil/Portals/59/Publications/MCO%206100.13%20W_CH%201.pdf

10.10 Saving Workouts to USB

With the 4Front treadmill, it is possible to save your workout information to a USB device to review on your computer and track your personal training progress over time.

This is possible with both the standard LED display and the Personal Trainer Display.

You cannot make your own programs and save them on the USB stick.

1. Insert USB stick into USB port beneath 4Front interface display.
2. Turn the treadmill ON. The treadmill will begin recording data to the USB from whatever time you insert it into the USB port until you finish training.
3. After inserting the USB, the LED display should light up "USB Good" or "USB FOUND" if the USB is compatible.
 - If the USB is incompatible or full, the LED display will light up "USB OFF".
 - If the USB is incompatible, a different USB will be necessary.
4. After completing workout, press the OFF button once and the screen will flash "USB Save".
5. Remove USB after the display powers down.

Uploading Data to Computer

The saved file (.XML format) contains your workout data including workout time, calories burned, distance (miles), speed (MPH), pace (s/mi), incline (%), vertical feet, heart rate (BPM), and METs.

1. Plug your USB into the computer.
2. Upload the .XML file to a designated folder on your computer.

Excel Importing

View your workout data through any of the following methods:

One method to view your raw workout data and compare multiple training sessions is through Microsoft® Excel.

1. Open Excel.
2. From the toolbar, select "Data" > "From Other Sources" > "From XML Data Import" option.
3. Locate your USB storage device, select a single workout, and click "Open".
 - A message box may pop up saying that Excel does not recognize the schema. Click "OK" and click "OK" again on the next pop-up.
 - The next screen will appear with all the raw data from your workout.
4. To compare another workout, click "Sheet2" at the bottom of the window and follow the above instructions to upload the second workout.

11 Options and Accessories

11.1 Power Input 208/230 V

The 208/230 VAC input voltage requirements are options for all WOODWAY treadmills.

An input power transformer for 208/230 VAC has been installed and connected.

This does not affect the other parts of the treadmill.

11.2 Reverse Mode - Bi-Directional Belt Control (US Models Only)

 **WARNING** 019

Do Not Leave Treadmill Unattended While in Reverse Mode!

If the treadmill is left unattended while in reverse mode, there is a possibility of personal injury from people stepping onto device while assuming the running surface will move normally.

- Never leave treadmill unattended while in reverse mode.
- Always use supervision while training in reverse mode.
- Always keep children and animals clear of the treadmill while in reverse mode.

The bi-directional belt control feature is an option on some models.

This option can only be activated if it was selected upon purchase.

The incline system is not affected by this option. In the reverse direction, speed is limited to approx. 5 MPH (8 km/h) for safety reasons.

Constant supervision is required while the treadmill is in reverse.

1. Hold down the SLOW button for 5 seconds while speed is set to 0 MPH (km/h).
2. The display will beep 3 times to let the user know reverse mode is in effect.
 - While in reverse mode, the SPEED will be displayed as a negative value (e.g. -2.3 MPH)
 - If on an LCD Personal Trainer Display Board, the LCD display will read "Reverse Mode"
3. To exit reverse mode, hold the SLOW button for 5 seconds while the speed is at 0 MPH (km/h).

The display will beep 3 times to let the user know that forward mode has been restored.

11.3 Top Speeds Upgrade

 WARNING 020	
Constant Supervision is Required!	
When training at faster speeds, especially from a top speed upgrade, there is an increased chance of injury or damage from falling.	
<ul style="list-style-type: none">• Always supervise users when training at top speed.• Do not train at top speed until you have reached a proper conditioning and training level necessary to train safely.	

Options are available to increase top speeds depending on the model. These options are mainly used for sports medicine and the training of elite, conditioned athletes (some will require 208/230V) and vary depending on the treadmill model.

11.4 RS-232 Remote Computer Control

This option enables you to switch between the treadmill display and a remote computer for remote control operation. Programs are available from WOODWAY. WOODWAY treadmills are tested to UL/CSA standards with an Intel DG41RQ computer.

11.5 Accessories and Services

The following accessories and services are available from WOODWAY:

Replacement Safety Magnet - P/N C2448

Protective Treadmill Floor Mat - P/N M1184

48" x 72" x 1/2" (122 x 183 x 1.27 cm)

Protect the flooring or carpeting below your WOODWAY and keep your treadmill clear of obstructions (i.e. thick or high-pile carpet)

WOODWAY Renewal Program

This entails having your treadmill shipped back to WOODWAY via Van Line (WOODWAY can coordinate these details; cost is additional).

Your treadmill will then be thoroughly renovated by a qualified WOODWAY Service Technician. Any worn/outdated features will be replaced.

The treadmill will then carry a one (1) year parts and labor warranty. It's like getting a brand new WOODWAY at a fraction of the cost.

Contact the WOODWAY Service Department or your sales representative to order at
1-800-WOODWAY (1-800-966-3929)

12 Cleaning/Disinfection and Maintenance

WARNING

Danger of Injury due to Lack of Qualifications!

If maintenance or repairs are not carried out by professionally qualified personnel, serious injury and material damage may occur.

- Maintenance and repair work may only be performed by qualified personnel.
- It is the sole responsibility of the representative to assign qualified personnel for maintenance and repair work.
- Clean and examine the machine regularly for damage and or wear, paying special attention to areas susceptible to wear.
- In case of doubt or questions, always contact WOODWAY Customer Service or your dealer.
- The manufacturer is not liable for personal injury and material damage caused by a lack of qualifications!

12.1 Cleaning

Periodic cleaning and inspection of your WOODWAY treadmill will help prolong its life while keeping it looking like new.

And while cleaning will keep your treadmill looking new, a good Preventative Maintenance Program will keep your treadmill running like new.

Contact WOODWAY Service for information on Preventive Maintenance programs to help you get the most from your treadmill for years to come.

WOODWAY continually evaluates chemical profiles and active ingredients of multiple cleaning and disinfecting products/wipes commonly used in fitness, medical and rehabilitation sectors.

The compatibility of these products with WOODWAY treadmills is assessed to ensure adherence to cleaning standards without compromising treadmill material integrity.

DANGER

Danger of Death by Electric Shock!

The use of water and liquid detergents as part of a cleaning can cause serious or fatal electrical shock.

- No liquids may contact electrical parts such as motor, power cord, power switch, and control monitors.
- Do not spray the device with a water jet.
- Pull power plug before cleaning; equipment must not be connected to power!
- Ensure the device cannot be switched back on.

Below are guidelines of recommended cleaning and maintenance intervals.

The running surface should be thoroughly cleaned at regular intervals, based on the intensity of use.

Best Practices and Recommendations for Cleaning WOODWAY Treadmills:

- See WOODWAY’s list of approved cleaning product recommendations.
- Always perform spot tests on hidden areas before regular use of any new cleaning product to avoid damage to component surfaces, observe the manufacturers instructions for detergent use.
- Apply cleaners with a soft cloth or sponge rather than spraying cleaners onto surfaces to avoid unneeded over-spray.
- Avoid excessive moisture around console seams, screens, and touch points.
- Do not use abrasive brushes or abrasive cleaners, as paint and plastic surfaces can be scratched.
- Do not use sharp tools (e.g. knife, metal scraper) or non- approved aggressive cleaning solvents for cleaning.
- Use only neutral pH, non-abrasive, and non-oxidizing cleaners that do not contain high concentrations of alcohol, bleach, or other oxidizers.
- See WOODWAY’s recommended cleaning products.
- After disinfecting and cleaning wipe down surfaces to prevent residue buildup.

Recommended Cleaning Schedule

Frequency	Task	Cleaner Type
Daily	Wipe console, touch-points, Railings	Neutral pH or AF3 (spot test)
Weekly	Frame/Powder-coated areas	TriBase®17 or mild soap and water
Monthly	Deep clean, safety and branding decal inspection	No alcohol, bleach or abrasives

Approved Cleaning Products - Safe for Regular Use

These cleaners have been tested or are known to be non-damaging to treadmill surfaces.

- **Spartan - TriBase® Multi-Purpose Cleaner (17)** (Clean on the Go) – Tested and safe for regular cleaning, offering an effective yet non-damaging solution.
- **Mild Dish Soap & Water** (e.g., Dawn® diluted in water) – Gentle and effective for general cleaning.

- **Simple Green® All-Purpose Cleaner** (diluted) – Neutral pH, non-corrosive, and safe for most surfaces.
- **Ecolab Neutral Floor Cleaner** – Designed for safe use on various hard surfaces.
- **Zep® Neutral pH Floor Cleaner** – A mild formula that avoids strong oxidizers or solvents.

Cleaning Products to use with Caution - Compatible, but May Cause Long-Term Effects

These products are widely used in the industry and are not banned, but may cause surface degradation over time (especially to powder-coated paint, acrylic windows/screens, or decals).

Important: With ANY of the following products wipe residue away promptly and avoid over-saturation.

- **Gym Wipes (2XL GymWipes® Professional)** These wipes contain quaternary ammonium compounds, which may degrade certain surfaces over time.
- **Zogics Antibacterial Wipes** - Zogics Antibacterial Wipes contain benzalkonium chloride (0.13%), a Quaternary Ammonium compound.
While alcohol-free and commonly used in the fitness industry, field observations indicate these wipes may cause dulling or discoloration of powder-coated paint over time.
- **70% Isopropyl Alcohol (Limited Use)** – Safe for disinfecting, but avoid prolonged exposure to prevent surface dulling.
- **PDI® Products - Sani-Cloth® AF3, Super Sani-Cloth®, and Easy Screen®** all contain chemicals found to discolor, degrade and or cause surface cracking and brittleness over time.
Products include Isopropyl Alcohol, Quaternary Ammonium and Sodium Hypochlorite.

Cleaning Products to Avoid - Known to Cause Damage

WOODWAY continually evaluates chemical profiles and active ingredients of multiple cleaning and disinfecting products/wipes commonly used in the fitness, medical and rehabilitation sectors.

The compatibility of these products with WOODWAY treadmills is assessed to ensure adherence to cleaning standards without compromising treadmill material integrity.

- **Spartan Chemical Clean by Peroxy® (15)** (Clean on the Go) Tested and confirmed to cause surface degradation due to its hydrogen peroxide content.
- **Ecolab Peroxide Multi-Surface Cleaner and Disinfectant.** Contains hydrogen peroxide (8.0%), which is an oxidizing agent that may cause surface degradation over time. Also contains dodecyl benzene sulfonic acid, which may contribute to surface wear.
- **Hydrogen Peroxide-based Cleaners** – Can cause material brittleness over time.
- **Acetone, Solvents and Strong Acidic/Alkaline** – May dissolve, weaken or breakdown treadmill surface integrity.

- **Bleach** (Sodium Hypochlorite-based products) – Causes discoloration and breakdown of materials.
- **Ammonia-based Cleaners** – May cause surface cracking and damage.
- **Abrasive Cleaners** – Can scratch and wear down surfaces.

12.2 Maintenance Intervals

 DANGER R3	
Danger of Death by Electric Shock!	
Maintenance and inspection work on the unit may cause serious or fatal electrical shock.	
<ul style="list-style-type: none">• Pull the power plug prior to any maintenance and inspection work on the equipment. The device must not be connected to the power.• Ensure the device cannot be switched back on.	

Weekly Maintenance

- Clean handrails, display, and side covers with a damp cloth
- Disinfect handrails and controls
- Clean the running surface with a damp, lint-free cloth
- Visually check the power cord for damage

Weekly Maintenance continued

- Check the treadmill for mechanical damage
- Check mounting of all controls (display, side panels)
- Clean the area under the treadmill (vacuum and mop)

 CAUTION Y4	
Risk of Injury Through Risk of Falling!	
Worn or damaged components must be replaced immediately. If the observed deficiency can cause danger to the user or operator of the treadmill, it needs to be taken out of service until repaired.	

Monthly Maintenance

A complete function test of the treadmill must be carried out every 2 - 4 weeks depending on the duration and intensity of use.

The function test includes the following:

1	Use the treadmill for a short time at speed of 3.5 - 6 MPH (6 - 10 km/h). Do unusual noises occur?
2	Turn up the treadmill to max. speed for a short time. Does the treadmill reach the specified max. speed? Do unusual noises occur?
3	Does the display correctly show the distance traveled at top speed?
4	Stop the treadmill and move it to max. incline. Does the treadmill reach the desired incline?
5	Do unusual noises occur while the treadmill is running at max. incline?
6	Check the Magnetic Emergency Stop function. Is an emergency stop initiated?
7	Set the treadmill to STAND-BY mode. Though slight movement is normal, the running surface must be very difficult to move. Is the running surface stopped correctly?

ATTENTION	BA3
<p>If there are defects or deviations in the control function, notify WOODWAY Customer Service immediately.</p> <p>The device must be taken out of service and disabled until repaired. Repairs may only be carried out by trained and authorized personnel.</p>	

Before starting any maintenance, disconnect incoming power, remove the side panels.

Preventative maintenance consists of the following measures:

- Clean the inside of the treadmill with a vacuum cleaner. Do not touch the electrical components (cables, transformers, connectors, circuit boards, etc).
- Visually check the drive unit toothed belt (drive belt) for cracks and other wear and missing or broken teeth.
- Inspect the aluminum profiles of the slats for damage.
- Visually inspect all mechanical components for damage (lifting mechanism, welded frame, side panels, treadmill feet, rollers on the lifting scissors, railings, display, emergency stop mushroom, emergency stop magnetic switch).
- In rare cases there may be bearing damage. Under certain circumstances this can be detected through excessive grease leakage from the bearing housing.
- Have the time limits prescribed by the manufacturer for the maintenance and safety checks been complied with?

A repair must take place in the following situations:

- Liquid has gotten into the device
- Damaged power cord (cable, plug)
- Defective drive system toothed belt
- Suspected bearing damage
- Suspected/established device defect
- Bucking, sudden stopping, or accelerating of the running surface
- Button(s) fail to function
- Burning smell, smoke, or unusual noises
- Malfunction (failure) of the emergency stop button
- Malfunction (failure) of the emergency stop magnet
- Damage to the running surface belt
- All other defects which may affect the safety of the device

Semi-Annual Maintenance

- Vacuum inside the treadmill (unplug device and remove side covers).
- Inspect all nuts and bolts. Tighten if necessary.
- Clean the running surface and spray with anti-static spray.
- Check the drive belt (replace if shredded or if teeth are missing).

Annual Maintenance

A complete function test of the treadmill must be carried out every 2 - 4 weeks depending on the duration and intensity of use.

The proper maintenance of the treadmill must take place annually in conjunction with the Technical Safety Checks (TSC).

In exceptional cases, the maintenance interval may be adapted to the extended inspection intervals in accordance with Technical Safety Checks (TSC).

Maintenance and repairs may only be carried out by trained and authorized personnel.

NOTICE

BN12

It is recommended to enter maintenance and repairs in the Maintenance Report.

Significant measures for inspection of the treadmill:

- Treadmill installation
- Running surface belt
- Drive unit and the lifting system
- Nuts and bolts
- Secondary bearing and guide rollers
- Electronics

For further information on maintenance procedures, refer to the separate service manual.

12.3 Maintenance Access Standard Handrail

The following maintenance procedures require removal of the Right and Left Side Panels and all four End Caps.

Required tool:

- #2 Phillips head screwdriver

1. Ensure the unit is disconnected from the incoming power supply.

Start by removing both right and left side covers using a #2 Phillips head screwdriver.



2. After removing the side covers the **Upper (1)** and **Lower Screws (2)** holding each End Cap may be removed to access the cross-shaft bearings.

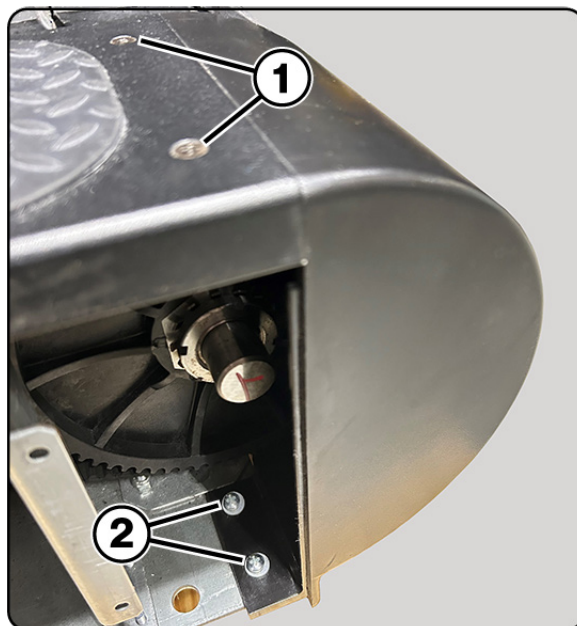

12.4 Maintenance Access Medical Handrail

Required tools:

- #2 Phillips head screwdriver
- 3/4" Combination wrench
- 24" - Bubble level or Digital level

1. To access the leveling feet located at each corner of the unit, both right and left side covers must be removed using a #2 Phillips head screwdriver.

Remove the nine screws per side securing the side covers.

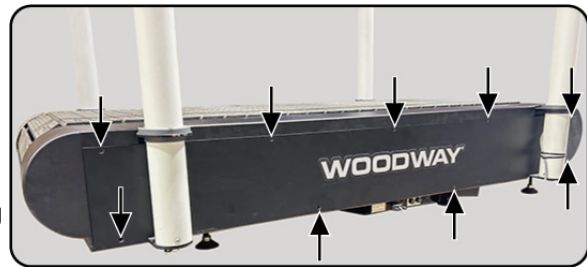

2. With the screws removed pull the bottom edge of the cover away from the chassis and slide the cover towards either the front or rear of the treadmill.

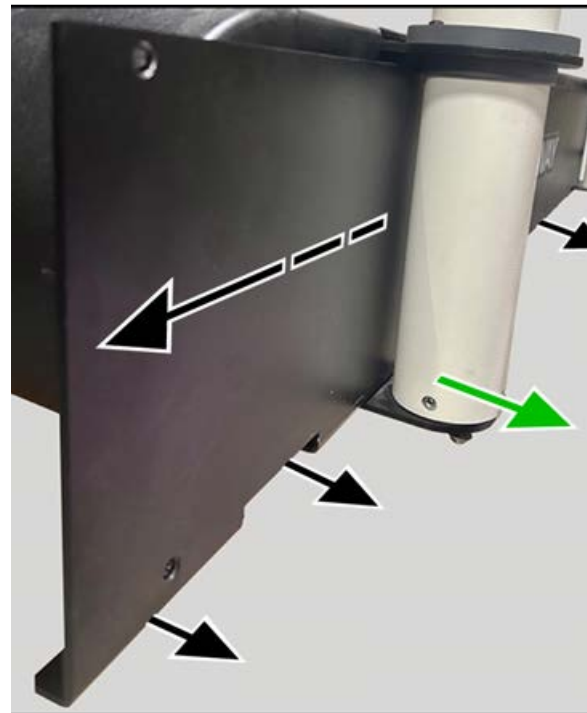

3. In some cases it may be necessary to loosen the two bolts on the bottom of handrail support and push the support away from the chassis to gain clearance to remove the cover.

Use a 5/32" (4mm) Allen Wrench, and a 9/16" wrench to loosen each bolt a couple turns.

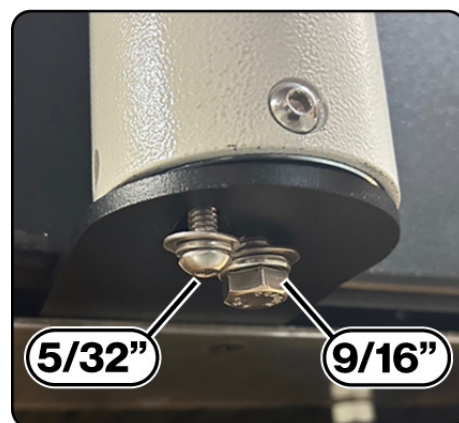

12.5 Lubrication

12.5.1 Bearings

Required Supplies:

- Grease Gun with flex hose
- Phillips head screwdriver
- 9/16" Combination Wrench

There are 2 Flange Mounted Pillow Block bearings located on the front axle that must be lubricated once a year using a grease gun.

Attach the grease gun to the **Zerk Fittings (1)** and gently squeeze one pump of grease into each bearing (pumping grease to fast can blow-out the bearing seals).

Use a 9/16" Combination Wrench to check the **Nuts Securing the Bearings (2)** to the frame, tighten if needed.

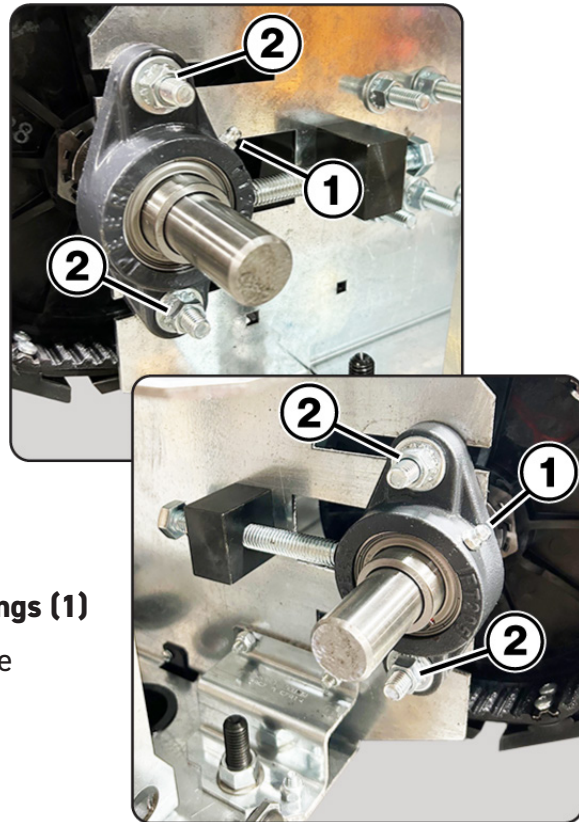

There are 2 Flange Mounted Pillow Block bearings located on the rear axle that must be lubricated once a year using a grease gun.

Attach the grease gun to the **Zerk Fittings (1)** and gently squeeze one pump of grease into each bearing (pumping grease to fast can blow-out the bearing seals).

Use a 9/16" Combination Wrench to check the **Nuts Securing the Bearings (2)** to the frame, tighten if needed.

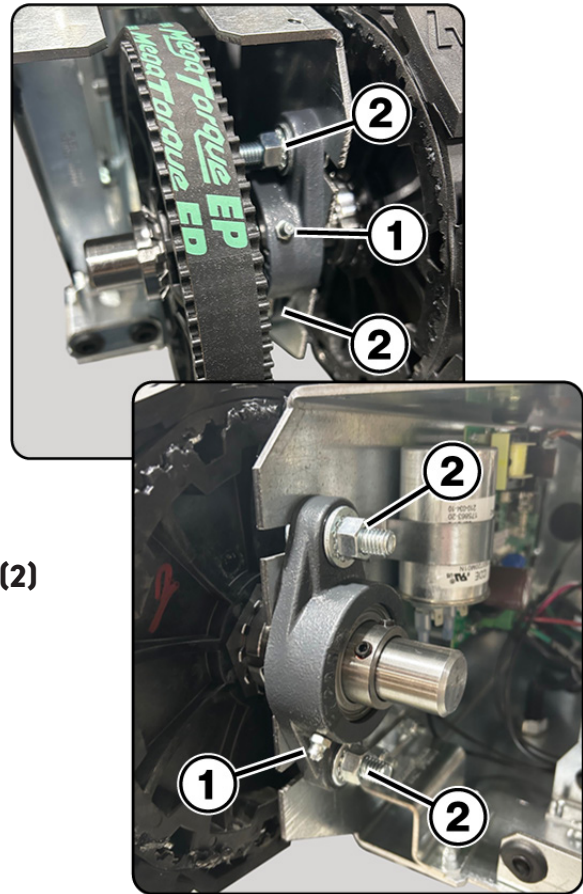

Note: Bearings used in the guide rollers and track support are sealed and do not need to be greased.

12.5.2 Running Surface Belt, Drive Axle

Required Supplies:

- Black Lithium Grease

The teeth of the tread belt are lubricated from the factory to minimize noise.

Over time the lubricant degrades and may need to have fresh lubricant applied to quite any belt noise that may occur.

With the side covers removed, there are 2 access ports on each side of the frame that allow lithium grease to be applied to the on the teeth of the drive belt.

With the power disconnected use a brush to sparingly apply grease to the belt teeth, apply a small amount on each side, then manually rotate the belt 8" to 10" inches and apply more lubricant.

Do this process approximately 10 times until you arrive at the starting point where the lubricant was first applied.

Note: Black Lithium Grease is recommended for lubricating the belt teeth as it is intended for more severe applications. White lithium tends to cake up and dry sooner due to additives.

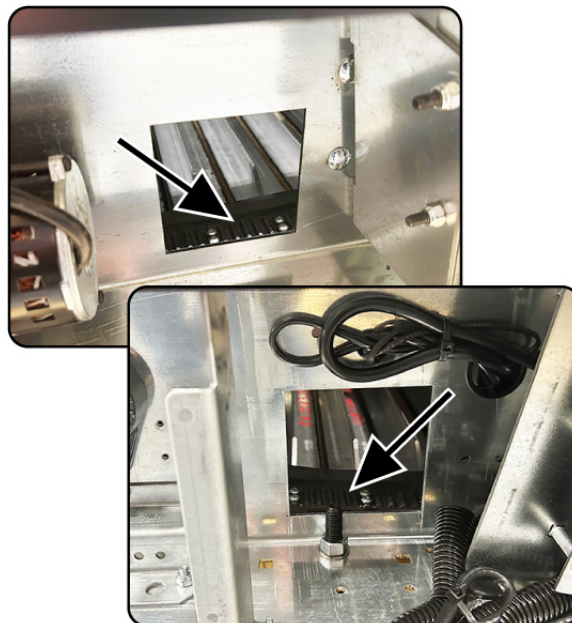

12.5.3 Drive Belt

Required Supplies:

- Black Lithium Grease

As with the running surface belt, the use of a small amount of grease on the teeth of the drive belt is only necessary to reduce any squeaking.

Grease should be used sparingly.

Remove the left side cover to access the drive belt assembly.

Note: Black Lithium Grease is recommended for lubricating the belt teeth as it is intended for more severe applications.

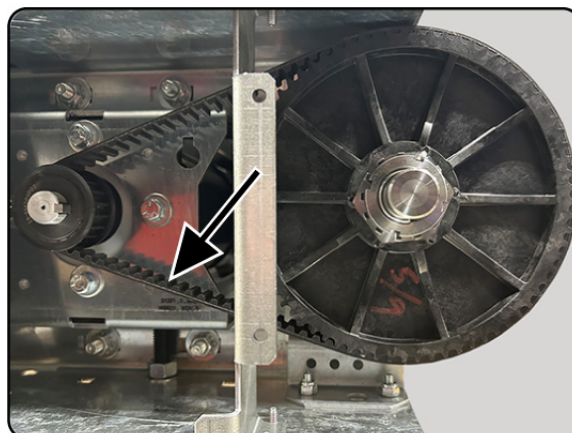

12.5.4 Incline System

Required Supplies:

- Black Lithium Grease
- Chain Lubricant/Oil (Dry)
- Clean rags, or cloths

With both side covers removed, there will be access to the incline system.

The incline systems on WOODWAY treadmills are lubricated at the factory.

The system should be checked during the monthly maintenance.

If required, apply a small amount of oil to the **Chains (1)** and **Lithium Grease (2)** to the incline drive racks.

Using a clean rag to wipe off any excess grease and oil that may have accumulated over time.

Chain Oil:

A good grade bicycle type chain oil is recommended for the chain drive mechanisms.

If possible, source a "Dry" type chain lubricant as it is less likely to collect dust.

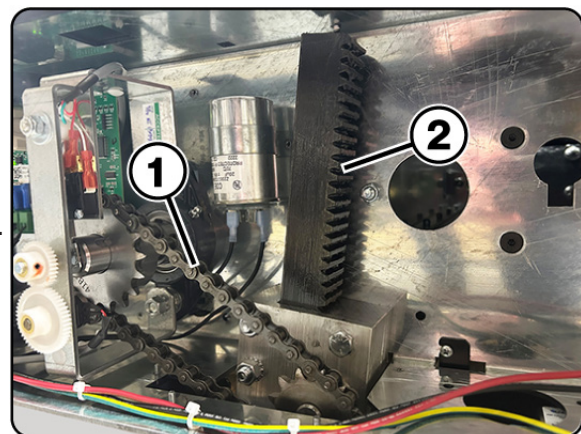
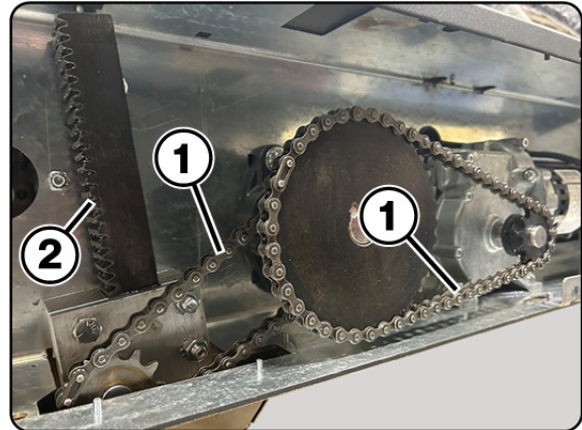

Note: Use a minimal amount of lubricant to prevent excess dirt and debris from sticking to the device after cleaning.

12.5.5 Control Console Support

The Medical Model Handrail Gantry has an adjustable console support, that over time may need to have the support tension adjusted.

At the base of the support mechanism are two Allen Wrenches, use the 5mm wrench to fine tune the console support arm

Turning the adjustment counterclockwise will increase the tension on the assembly, while clockwise will decrease the tension.

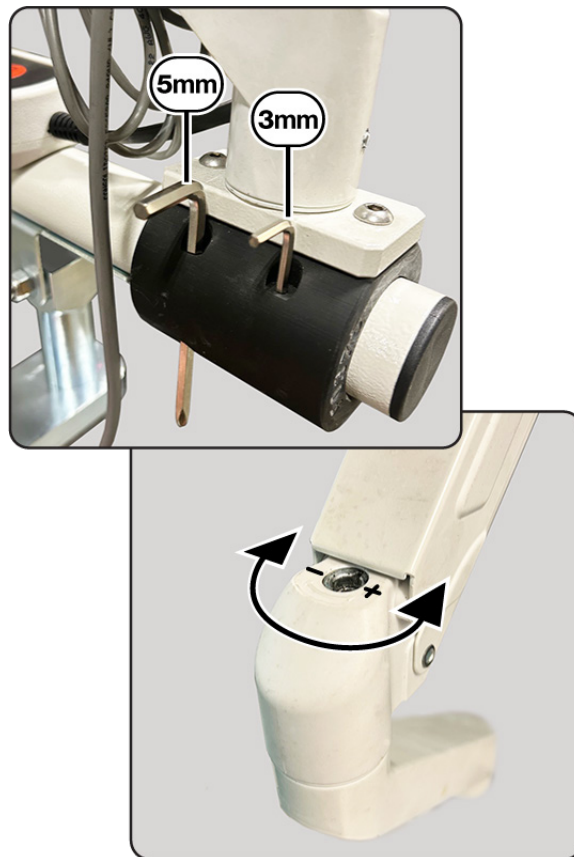

12.6 Adjusting and Calibrating

Adjustments and calibrations should only be performed by certified WOODWAY technicians, or certified distributor technicians.

Contact WOODWAY customer service:

European Representative/Importer:

WOODWAY GmbH
Steinackerstr. 20
79576 Weil am Rhein
Germany
Tel.: + 49 (0) 7621-940 999-0
Fax.: + 49 (0) 7621-940 999-40
E-mail: info@WOODWAY.de
Web www.WOODWAY.de

Sales:

Tel.: +49 (0) 7621 - 940 999 - 10
E-Mail: vertrieb@woodway.de

Customer Service:

Tel.: +49 (0) 7621 - 940 999 - 14
E-Mail: service@woodway.de

Manufacturer:

WOODWAY USA, Inc.
W229 N591 Foster Ct.
Waukesha, WI 53186
USA
Tel.: 1-262-548-6235
Fax.: 1-262-522-6235
E-mail: info@WOODWAY.com
Web www.WOODWAY.com

Technical Support:

Tel.: 1-800-WOODWAY Ext 3
E-Mail: service@woodway.com

12.7 Disabling the Treadmill

Disabling is required if the safety of the treadmill is not guaranteed or if it is suggested that this could be the case.

A device must be disabled if the following symptoms occur:

- Unusual noises
- Appearance of smoke
- Uncontrolled stopping or accelerating of the treadmill
- Rocking of the running surface belt
- Damage to slats or other mechanical damage
- Spilling of liquid on the treadmill
- Other symptoms/situations which could cause danger to the user/operator

Disabling can also be requested of WOODWAY Customer Service by telephone.

In this case, the treadmill representative is obliged to carry out the disabling and to confirm with WOODWAY

Customer Service in writing.

ATTENTION

BA4

The representative is responsible for property damage or personal damages caused by incorrectly disabling or not disabling the treadmill.

The disabling of the treadmill must be such that an unintentional and/or unauthorized restart can be ruled out and that the name of person who is authorized to put the treadmill back into operation can be seen.

The representative is to disable medical treadmills in the following situations:

- There is reasonable suspicion of danger to the health and safety of patients, employees, or third parties
- Defects exist that could endanger patients, employees, or third parties

The removal of the power plug from the outlet alone is not sufficient for the disabling of the treadmill, since third persons who have not been informed about the disabling could plug the treadmill back into the power supply and use it.

The following measures must therefore be taken to disable a WOODWAY medical tread-mill:

1. The unit must be turned off and the power plug must be unplugged/disconnected from the wall socket.
2. The treadmill must be marked "disabled" in a clear manner such as: "CAUTION DANGER OF INJURY" and the notice must be clearly displayed. In addition, the date of disabling, reason for disabling, and name of the person/organization that disabled must be specified.

3. It must be determined which authorized person - possibly after maintenance and repair may start up the treadmill again.
4. The fuses must be removed from the power supply box and kept in a safe place.
Attach one of the following safety labels to the treadmill power supply fuse box.
5. Apply the second safety label to the plug of the power cord.



○



**CAUTION
DANGER OF INJURY**

**This device has been disabled due to safety defects.
THE USE OF THIS DEVICE IS STRICTLY FORBIDDEN!**

Device was disabled on (date) : _____

By (name): _____

**Only the following person may put this device back
into operation: _____**





○



**CAUTION
DANGER OF INJURY**

**This device has been disabled due to safety defects.
THE USE OF THIS DEVICE IS STRICTLY FORBIDDEN!**

Device was disabled on (date) : _____

By (name): _____

**Only the following person may put this device back
into operation: _____**



12.8 Device Fuses

Located on the lower front right corner of the unit's chassis is the Main Fuse panel.

The fuses must comply with the published technical specifications in Chapter 3.6

NOTE: Bridging fuses is prohibited, due to the risk of electric shock and fire.

When replacing a fuse, turn power OFF using the main power switch and unplug the power cord from the outlet.

Unscrew the fuse holder from the power panel,

Change the fuse and screw the fuse holder back into the power panel.

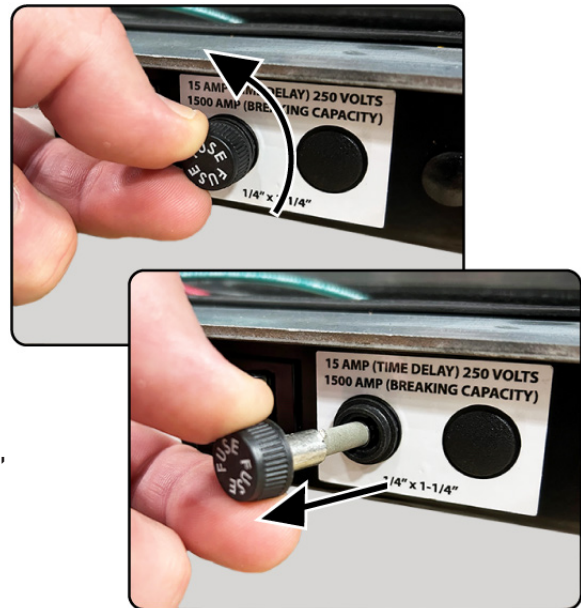

13 Troubleshooting

ATTENTION

With the exception of the maintenance work described in this chapter, the treadmill can only be checked and repaired by qualified personnel. If necessary, contact an authorized WOODWAY dealer or WOODWAY Service Center.

If you have problems with your treadmill, please consider the answers to the following questions before calling WOODWAY Customer Service:

- What is the make, model, and serial number?
- What happened before the problem occurred?
- Did the problem occur suddenly or slowly over time?
- Was the treadmill in use when the problem occurred?
- Was the running surface ENGAGED or was it in DYNAMIC MODE?
- Explain all the other information that you consider relevant.

13.1 Unusual Noises

Visual Inspection

Perform a visual inspection of the running surface belt and verify that the running surface is not obstructed by an object under, in front of, or near the device.

Remove any obstacles that could obstruct or damage the running surface.

Check whether the running surface inadvertently brushes against the side panel and leads to excessive wear.

If this is the case, correct the gaps between the running surface and side panel.

Bearings

When noises come from the bearings, bearing damage is to be expected. If this is the case, the bearing must be replaced by a trained and authorized technician.

Toothed V-Belt

The teeth on the bottom of the tread belt are sufficiently lubricated in the factory to minimize the noise.

In certain cases, it may occur that the combination toothed V-belt rubs against the pulley guides, thus producing whistling sounds.

In this case, the use of a small amount of lubricant (Molykote or similar product) applied to the edges of the endless belt can contribute to noise reduction.

Do not use too much grease, as this leads to an unnecessary accumulation of dust and dirt. ([See 12.5.2 Running Surface Belt, Drive Axle](#))

Toothed Belt Drive

As with the running surface belt, the use of a small amount of lubricant on the edge of the belt is only necessary to reduce a "whistling" of the belt.

Lubricants should always be used sparingly. ([See 12.5.2 Running Surface Belt, Drive Axle](#))

13.2 No Display

If the display is not lit when you turn on the treadmill, check the following points:

- Is the treadmill connected to the power source?
- Is the main switch on the power connector box switched on?
- Check that the power main's input fuse is properly functioning (replace if defective).
- Can the fan that is used to cool the servo controller (on the runner's right) be heard?
- Does the socket to which the treadmill is connected supply power (e.g. could the circuit breaker for the supply line have been triggered)?

13.3 Running Surface Does Not Move

If the display and/or lifting mechanism works but the treadmill does not accelerate when the [+] button is pressed, do the following:

- Ensure the emergency stop magnet is in place. Try to reposition the magnet.
- Ensure the emergency stop button is in the released position. If the button is activated, twist clockwise to release.
- Check if the running surface belt is blocked by an object and if so, remove.
- Turn off the power at the main switch and unplug the power cord. Wait 60 seconds before reconnecting to power and turning on the main switch.

13.4 Free Moving Running Surface

It is always possible to rotate the running surface belt slowly when the drive is not engaged.

The more energy used to move the running surface, the greater the motor's braking effect (short circuit brake). This behavior is normal.

When the drive is not engaged (i.e. STAND-BY mode) the running surface belt is slowed down by a short circuit of the three motor phases.

A totally free-moving running surface belt might be a defective short circuit relay or a broken wire.

If the treadmill is turned on by the switch on the display and the indicator in the display is active, this is a sign that the motor is defective, or it is a failure of the servo controller.

In both cases the treadmill must be disabled immediately according to the instructions in this manual.

13.5 Incline Does Not Function

- If the incline motor makes noises, a brake may be stuck, or the motor may have stopped.
- Check if the incline-limit switch has been tripped.
- Ensure that the chain is not broken and has not slipped from the sprocket.
- Ensure that the potentiometer is set properly.

13.6 Irregular or Flashing Display

- Ensure that the treadmill is connected to an independent power line.
- Verify power source is rated to match the electrical specifications listed on your unit's serial label.
- The power supply for the display on the interface card may be defective; contact WOODWAY Customer Service.

13.7 Sources of Electromagnetic Interference

Close proximity to, for example, X-ray equipment, powerful motors, or isolating transformers must be avoided because of possible electromagnetic interference.

Electromagnetic interference can affect the operation of your treadmill.

13.8 Interference of the POLAR® Heart Rate Monitor

During the transfer of data from the transmitter to the receiver the POLAR® heart rate monitoring may receive interference, which is triggered by other devices in the proximity of the treadmill. The most common causes for this are:

- PC screens, computers, radio systems of all kinds
- High tension power lines
- Intense light exposure
- Strong magnetic fields

14 Replacing Parts

NOTICE BN1

The use of NON-original replacement parts may change the characteristics of the device and interfere with the safe usage.
WOODWAY does not accept liability for damages resulting from NON-original or modified parts being used.

DANGER R6

Danger of Death by Electric Shock!

Fatal electrical shock may occur if the unit is not disconnected from the power supply before assembly or disassembly.

- The device must be stopped, switched off, and unplugged prior to being worked on.
- Ensure the device cannot be switched back on.
- After the power is disconnected wait 10 minutes to ensure that live electrical components (e.g. capacitors) have discharged.
- Lock out Tag out device if left unattended.

For detailed instructions or to schedule a WOODWAY service technician contact the WOODWAY Service Department.

Manufacturer:

WOODWAY USA, Inc.
W229 N591 Foster Ct.
Waukesha, WI 53186
USA
Tel.: 1-262-548-6235
Fax.: 1-262-522-6235
E-mail: service@WOODWAY.com
Web www.WOODWAY.com

Technical Support:

Tel.: 1-800-WOODWAY Ext 3
E-Mail: service@woodway.com

European Representative:

WOODWAY GmbH
Steinackerstr. 20
79576 Weil am Rhein
Germany
Tel.: + 49 (0) 7621-940 999-0
Fax.: + 49 (0) 7621-940 999-40
E-mail: info@WOODWAY.de
Web www.WOODWAY.de

Customer Service:

Tel.: +49 (0) 7621 - 940 999 - 14
E-Mail: service@woodway.de

For faster processing of your request please have the following data and information available:

- Information on the name plate (specific model/serial number)
- An accurate description of the circumstances
- Customer number (if available)
- What action has already been taken

Servicing: The address of your local service center can be obtained from the manufacturer. After repair or re-installation, the actions listed under "Setup and Placement" ([see Chapter 6. Page 38](#)) are to be performed as during installation.

15 Warranty Information

	Frame	Drive Board / Drive Motor Running Belt	Remaining Parts	Labor
Home Use	15 years	5 years	5 years	3 years
Medical Use	10 years	5 years	3 years	1 year
Commercial Use	10 years	5 years	3 years	1 year

WOODWAY warrants that all products and accessories will be free from manufacturing defects according to the applications/terms listed above.

The warranty period commences on the original date of purchase (with the exception of the running belt assembly, which is warranted for a period of (5) years from the original date of purchase).

This warranty is given only to the original purchaser.

This warranty does not cover damage or equipment failure resulting from misuse, abuse, or failure to comply with electrical codes.

Further, this warranty shall not apply if there is any modification to the products or accessories or if there is a failure to provide maintenance procedure documentation as outlined in the Owner's Manual.

**WOODWAY GIVES NO OTHER WARRANTIES, EITHER EXPRESSED OR IMPLIED.
THE WARRANTY OF FITNESS FOR A PARTICULAR USE IS HEREBY DISCLAIMED.**

The buyer's remedy for breach of the expressed warranties contained herein shall be limited to the return of the product and accessories and repayment of the original purchase price.

However, provided at WOODWAY selection, it may repair and replace the non-conforming goods or parts. WOODWAY shall not be liable for any incidental or consequential damages.

Our Guarantee

WOODWAY guarantees the repurchase of WOODWAY treadmill products for a period of up to five (5) years after original installation, contingent on proof of annual preventative maintenance completion.

A direct payment, or credit toward the purchase of a new WOODWAY, based on the purchase price (excluding original shipping, installation, taxes and customization) of the treadmill will be made to the original owner of a WOODWAY treadmill.

This guarantee is limited to the original owner. Contact WOODWAY for further details on percentage and restrictions.

A Preventative Maintenance Program will protect your investment and keep your treadmill running like new.

Contact WOODWAY Service for information on Preventive Maintenance programs to help you get the most from your treadmill for years to come.

[WOODWAY Service Contact 2.5](#) (page 23)

17 Worksheets

Fitness Test Protocol Worksheet

Name: _____

Resting Heart Rate: _____ Trial 1: _____ Trial 2: _____ Trail 3: _____

Blood Pressure: _____ Trial 1: _____ Trial 2: _____ Trail 3: _____

Weight: _____ lbs. kg. Training Heart Rate (85% of HR max) _____

Fitness Test Protocol Worksheet

Name: _____

Resting Heart Rate: _____ Trial 1: _____ Trial 2: _____ Trail 3: _____

Blood Pressure: _____ Trial 1: _____ Trial 2: _____ Trail 3: _____

Weight: _____ lbs. kg. Training Heart Rate (85% of HR max) _____

Fitness Test Protocol Worksheet

Name: _____

Resting Heart Rate: _____ Trial 1: _____ Trial 2: _____ Trail 3: _____

Blood Pressure: _____ Trial 1: _____ Trial 2: _____ Trail 3: _____

Weight: _____ lbs. kg. Training Heart Rate (85% of HR max) _____

Fitness Test Protocol Worksheet

Name: _____

Resting Heart Rate: _____ Trial 1: _____ Trial 2: _____ Trail 3: _____

Blood Pressure: _____ Trial 1: _____ Trial 2: _____ Trail 3: _____

Weight: _____ lbs. kg. Training Heart Rate (85% of HR max) _____

Fitness Test Protocol Worksheet

Name: _____

Resting Heart Rate: _____ Trial 1: _____ Trial 2: _____ Trail 3: _____

Blood Pressure: _____ Trial 1: _____ Trial 2: _____ Trail 3: _____

Weight: _____ lbs. kg. Training Heart Rate (85% of HR max) _____

18 Disposal

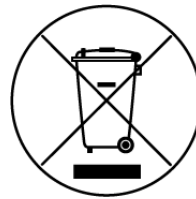

Electrical and electronic devices must be disposed of separately from normal household waste.

An appropriate waste disposal company should be contacted. Properly dispose of the device at the end of its service life (e.g. the local collection point for waste separation):

- The device packaging is disposed of through resource recycling.
- The metal parts of the machine go to scrap metal disposal.
- Plastic parts are given to plastic recycling.
- Rubber parts are disposed of as hazardous waste.

The disposal of the equipment must be in accordance with the respective national regulations.

Wear parts are considered hazardous waste. After being replaced, wear parts must be disposed of according to country-specific waste laws.

Batteries may not be disposed of in household trash. Dispose of them at a battery collection point.

