

For The Long Run[®]

WOODWAY[®]

**Suspension System for Static and
Dynamic Body Weight Support in
Locomotion Therapy**

LokoStation 55/70

LokoStation ELVETA 55/70



Translation of the Original German Operating Manual

Edition: 01/2022-v4.0en



Sales:

WOODWAY GmbH
Steinackerstr. 20
79576 Weil am Rhein
Germany

Tel.: +49 (0) 7621 - 940 999 - 0
Fax.: +49 (0) 7621 - 940 999 - 40
E-mail: info@woodway.de
Web: www.woodway.de

Sales:

Tel. +49 (0) 7621 - 940 999 - 10
E-mail: vertrieb@woodway.de

Customer Service:

Tel. +49 (0) 7621 - 940 999 - 14
E-mail: service@woodway.de

Manufacturer:

Parabel s.r.o.
Paďělky 192
Lukov 763 17
Czech Republic

SRN: CZ-MF-000002892

Tel.: +420 (0) 577 - 112 - 060
Fax.: +420 (0) 577 - 911 - 505
E-mail: info@parabel.cz
Web: www.parabel.cz

Table of Contents

Table of Contents

1	Introduction	5
1.1	Operating Instruction Information	5
1.2	Model Designation.....	6
1.3	Limitation of Liability	6
1.4	Copyright	7
1.5	Replacement Parts	7
1.6	Customer Service	8
1.7	EU Declaration of Conformity	9
	1.7.1 LokoStation	9
	1.7.2 LokoStation ELVETA.....	10
2	Safety.....	11
2.1	General	11
2.2	Description of Warning Notices	11
2.3	Markings on Device	12
2.4	Personnel Qualification and Responsibility.....	13
2.5	Intended Use.....	14
2.6	Unauthorized Modes of Operation	16
2.7	Contraindications	16
2.8	Safety Requirements for Patient Harnesses	17
2.9	Electromagnetic Compatibility (EMC)	18
3	Technical Data	19
3.1	Name Plate.....	19
3.2	Dimensions and Weights.....	21
3.3	Technical Specifications	22
	3.3.1 LokoStation	22
	3.3.2 ELVETA Lift Motor.....	23
4	Transportation and Storage.....	24
4.1	Safety Notices for Transportation	24
4.2	Transport Notice	24
4.3	Storage	24
5	Product description.....	25
5.1	Main Components	25
5.2	Function Description.....	26
5.3	Patient Harness.....	27
6	Commissioning	29
6.1	General	29
6.2	Installation	29
7	Operation	30
7.1	Wheel Chair Ramp	30
7.2	Suspension Rope Width Adjustment	31
7.3	Body Weight Support	33
	7.3.1 Static Body Weight Support	33
	7.3.2 Dynamic Body Weight Support.....	34
7.4	The ELVETA Lift Motor.....	36
	7.4.1 Function.....	37
	7.4.2 Remote Control	37
	7.4.3 Power Supply (Charging the Batteries)	38
	7.4.4 Lift Motor Operation.....	38
	7.4.5 Emergency Lowering.....	39

Table of Contents

7.5 Therapist Seats 40

7.6 Rope Length Adjustment 40

7.7 ELVETA Rope Length Adjustment 42

7.8 Patient Harness..... 43

 7.8.1 Safety Buckles 44

 7.8.2 Applying the Patient Harness 45

 7.8.3 Hip Stabilization..... 47

 7.8.4 Harness Fastener 48

8 Options and Accessories 49

 8.1 Order Numbers 49

 8.2 Overview of Accessories 49

 8.3 Installation Kit for PPS Treadmill 49

 8.4 Patient Harness and Accessories 50

9 Maintenance and Cleaning 51

 9.1 Cleaning 51

 9.2 Maintenance Intervals 52

 9.2.1 Daily Maintenance 52

 9.2.2 Weekly Maintenance 52

 9.2.3 Semiannual Maintenance 52

 9.2.4 Annual Maintenance..... 52

 9.3 Patient Harness..... 53

 9.3.1 Maintenance..... 53

 9.3.2 Cleaning..... 54

 9.4 Troubleshooting 55

 9.4.1 LokoStation 55

 9.4.2 LokoStation ELVETA..... 56

10 Instruction Record 57

11 Guidance and Manufacturer´s declaration 60

12 Incident Report 63

13 Disposal..... 64

14 Table of Figures 65

Introduction

1 Introduction**1.1 Operating Instruction Information**

This manual provides information on the safe operation of the LokoStation.

One condition for safe operation is compliance with all safety and operating instructions.

⚠ CAUTION**Improper operation can cause accidents!**

Not using the LokoStation as intended according to the manufacturer's instructions can cause accidents and equipment damage.

- ▶ These operating instructions must be completely read and understood before using the treadmill.
- ▶ Keep these instructions close at hand for all users of the device.

Read and observe the operating instructions!

Read these instructions carefully before beginning any work on the device! It is a part of the product and must be kept accessible at all times and in the immediate vicinity of the treadmill for operating and maintenance personnel.

Observe the Instructions!

WOODWAY accepts no liability for accidents, equipment damage and consequences of equipment failure that are a result of failure to follow the operating instructions. In addition, the local accident prevention regulations and general safety conditions for intended use of the treadmill apply.

WOODWAY reserves the right to make technical changes in the context of improving the performance properties and further development without prior notice. Illustrations are for basic understanding and may differ from the actual design of the device.

Accessories from other suppliers have further safety regulations and guidelines.

WOODWAY accepts no liability for accidents, equipment damage and personal injury caused by the use of accessories from other suppliers.

1.2 Model Designation

The LokoStation/LokoStation ELVETA may only be used in combination with a **WOODWAY** PPS series medical treadmill.

The following table shows the possible LokoStation/LokoStation ELVETA combinations with a weight relief system with patient harness and a **WOODWAY** PPS series medical treadmill.

Model Designations	
LokoStation / LokoStation ELVETA	WOODWAY PPS Series Treadmills
LokoStation 55	PPS 55 Plus
LokoStation 55 ELVETA	
LokoStation 70	PPS 70 Plus
LokoStation 70 ELVETA	

1.3 Limitation of Liability

All information and instructions in this manual have been compiled in accordance with applicable standards and regulations, the current state of technology and our knowledge and experience.

WOODWAY accepts no responsibility for damages resulting from:

- Disregarding the operating instructions
- Improper use
- Use by non-authorized persons
- Use of replacement parts which were not approved by **WOODWAY**.
- Unauthorized modifications to the device or accessories.

The **WOODWAY** general terms and conditions and delivery conditions apply, as well as the legal regulations valid at the time of contract conclusion.

Introduction

1.4 Copyright

The release of the operating instructions to third parties without the written permission of **WOODWAY** is prohibited.

NOTE

All contents, text, drawings, images or other illustrations are copyright protected and are subject to intellectual property rights.
Any misuse is punishable by law!

Duplication in any manner and form - including excerpts - as well as use and/or communication of the content are not permitted without written permission from **WOODWAY**.

1.5 Replacement Parts

WOODWAY recommends the use of original replacement parts. Original replacement parts have particular qualities and ensure reliable and safe operation;

- Development for specific use with the device,
- Manufacture in high quality and excellence,
- Ensuring the legal warranty period (excluding wear parts) or other reached agreements.

NOTE

The use of NON-original replacement parts may change the characteristics of the device and interfere with the safe use!
WOODWAY does not accept liability for damages resulting from this.

Disposal! Wear parts are considered hazardous waste!

After being replaced wear parts must be disposed of according to country-specific waste laws.

For further information on disposal, see section 10 page 57.

1.6 Customer Service

For service questions contact the following:

Woodway GmbH
Steinackerstr. 20
79576 Weil am Rhein
GERMANY

Contact: Tel. +49 (0) 7621 - 940 999 - 14
Fax. +49 (0) 7621 - 940 999 - 40
Email: service@woodway.de

For faster processing of your request please have the following data and information available:

- Information on the nameplate (specific model/serial number)
- An accurate description of the circumstances
- What action has already been taken

Servicing: When servicing on site the LokoStation and connected devices must be disconnected from the power supply by a qualified electrician so that the device cannot switch on accidentally.

The address of your responsible service center can be obtained from **WOODWAY**. After repair or re-commissioning, the actions listed under "Installation" and "Commissioning" are to be performed as during commissioning.

Introduction

1.7 EU Declaration of Conformity

1.7.1 LokoStation



EU Declaration of Conformity			Parabel s.r.o. SOLUTIONS FOR YOUR VISIONS » » » » » » » » » »
EU - Konformitätserklärung			
Manufacturer:	Parabel s.r.o.		
Hersteller:	Padělky 192 763 17 Lukov, Czech Republic		
Single Registration Number:	CZ-MF-000002892		
Product Description:	Suspension system for static and dynamic body weight support in locomotion therapy		
Produktbezeichnung:	Aufhängesystem zur dynamischen Gewichtsentlastung bei der Lokomotionstherapie		
Product:	LokoStation		
Produkt:			
Product Types:	LokoStation 55		
Typenbezeichnung:	LokoStation 70		
Classification:	I (per Annex VIII Rule 1 regulation (EU) MDR 2017/745)		
Klassifizierung:	I (gemäß Anhang VIII Regel 1 der Richtlinie (EU) MDR 2017/745)		
Basic UDI-DI:	859420759LS33		
Basis UDI-DI:			
GMDN Code:	64812		
<p>We declare under our sole responsibility that the product specified above, in the delivered version, conforms to the requirements of regulation (EU) MDR 2017/745. The associated documentation will be kept at the manufacturer's premises.</p> <p><i>Wir erklären in alleiniger Verantwortung, dass das oben genannte Produkt in der gelieferten Ausführung den Anforderungen der Verordnung (EU) MDR 2017/745 entspricht. Die zugehörige Dokumentation wird beim Hersteller aufbewahrt.</i></p>			
<p>The  symbol will be applied to the products.</p> <p>Das  Zeichen wird auf den Produkten angebracht.</p>			
Applicable Standards:	ČSN EN 60601-1 ed.2:2007	ČSN EN ISO 14971:2019	
Anwendbare Normen:	ČSN EN ISO 15223-1:2016	ČSN EN ISO 13485:2016	
	ČSN EN 60601-1-2 ed.3:2016		
<p>The conformity is confirmed by ČSN EN ISO 13485:2016 Certificate no. 42010361, which was created by LL-C (Certification) Czech Republic s.r.o.</p> <p><i>Die Konformität wurde mit dem ČSN EN ISO 13485:2016 Zertifikat Nr. 42010361, welches von LL-C (Zertifizierung) Tschechische Republik.</i></p>			
<p>This declaration of conformity is valid for all the models listed above, which were produced on or after 25.05.2021 by Parabel s.r.o. The validity of this declaration of conformity ends with the publication of a new declaration of conformity if this becomes necessary due to technical modifications or changes in the standards.</p> <p><i>Die Konformitätserklärung gilt für alle oben gelisteten Modelle die ab dem 25.05.2021 durch Parabel s.r.o. hergestellt worden sind. Die Gültigkeit dieser Konformitätserklärung endet mit der Veröffentlichung einer Konformitätserklärung neueren Datums, falls dies durch technische Änderungen oder durch gesetzliche Änderungen der Normen und Standards erfolgen muss.</i></p>			
CZ 763 17, Lukov, 25.05.2021			
 Michael Krüsselin Managing Director			
Version: 8 /2021		Page 1/1	

Fig. 1 EU Declaration of Conformity, LokoStation

1.7.2 LokoStation ELVETA



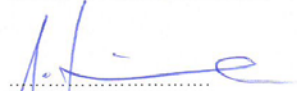

EU Declaration of Conformity EU - Konformitätserklärung		 Parabel s.r.o. SOLUTIONS FOR YOUR VISIONS
Manufacturer:	Parabel s.r.o.	
Hersteller:	Padělky 192 763 17 Lukov, Czech Republic	
Single Registration Number:	CZ-MF-000002892	
Product Description:	Suspension system for static and dynamic body weight support in locomotion therapy with an electric drive	
Produktbezeichnung:	Aufhängesystem zur dynamischen Gewichtsentlastung bei der Lokomotionstherapie mit elektrischem Antrieb	
Product:	LokoStation ELVETA	
Produkt:		
Product Types:	LokoStation 55 ELVETA	
Typenbezeichnung:	LokoStation 70 ELVETA	
Classification:	I (per Annex VIII Rule 13 regulation (EU) MDR 2017/745)	
Klassifizierung:	I (gemäß Anhang VIII Regel 13 der Richtlinie (EU) MDR 2017/745)	
Basic UDI-DI:	859420759LSELVR3	
Basis UDI-DI:		
GMDN Code:	58875	
<p>We declare under our sole responsibility that the product specified above, in the delivered version, conforms to the requirements of regulation (EU) MDR 2017/745 and directive 2014/30/EU. The associated documentation will be kept at the manufacturer's premises.</p> <p><i>Hiermit erklären wir in alleiniger Verantwortung, dass das oben genannte Produkt in der gelieferten Ausführung den Anforderungen der Richtlinie (EU) MDR 2017/745 und der in Richtlinie 2014/30/EU. Die dazugehörige Dokumentation wird in den Räumlichkeiten des Herstellers aufbewahrt.</i></p>		
<p>The  symbol will be applied to the products.</p> <p>Das  Zeichen wird auf den Produkten angebracht.</p>		
Applicable Standards:	ČSN EN 60601-1 ed.2:2007	ČSN EN ISO 14971:2019
Anwendbare Normen:	ČSN EN ISO 15223-1:2016	ČSN EN ISO 13485:2016
	ČSN EN 60601-1-2 ed.3:2016	
<p>The conformity is confirmed by ČSN EN ISO 13485:2016 Certificate no. 42010361, which was created by LL-C (Certification) Czech Republic s.r.o.</p> <p><i>Die Konformität wurde mit dem ČSN EN ISO 13485:2016 Zertifikat Nr. 42010361, welches von LL-C (Zertifizierung) Tschechische Republik.</i></p>		
<p>This declaration of conformity is valid for all the models listed above, which were produced on or after 25.05.2021 by Parabel s.r.o. The validity of this declaration of conformity ends with the publication of a new declaration of conformity if this becomes necessary due to technical modifications or changes in the standards.</p> <p><i>Die Konformitätserklärung gilt für alle oben gelisteten Modelle die ab dem 25.05.2021 durch Parabel s.r.o. hergestellt worden sind. Die Gültigkeit dieser Konformitätserklärung endet mit der Veröffentlichung einer Konformitätserklärung neueren Datums, falls dies durch technische Änderungen oder durch gesetzliche Änderungen der Normen und Standards erfolgen muss.</i></p>		
CZ 763 17, Lukov, 25.05.2021		
 Michael Krüsselin Managing Director		
Version: 8 /2021		
Page 1/1		

Fig. 2 EU Declaration of Conformity, LokoStation ELVETA

Safety

2 Safety

2.1 General

The LokoStation has been reliably designed, manufactured and tested according to the latest state of technology and is in safe and technically perfect condition. Nevertheless, the device can cause risk to persons and property if it is operated improperly.

For this reason the operating instructions should be read completely and safety instructions must be observed.

Warnings attached directly to the device must be observed and kept in a legible condition.

Inappropriate use will result in the rejection of any liability or guarantee by **WOODWAY**.

2.2 Description of Warning Notices



Warning notices indicate potential hazards or safety risks. They are indicated in this manual by a color-coded signal word panel (symbol with the appropriate signal word).

All warning notices have the same design and the same standardized content design.

Example of a Warning Notice:





 SIGNAL WORD	
Warning Text, Type and Source of Danger	
Description of the consequences of ignoring the danger.	
▶ Measures, instructions and forbidden actions to avoid the hazard.	

Classification:

NOTE	NOTE or WARNING (no danger symbol) No risk of injury, pertinent information and warning against material damage.
 CAUTION	CAUTION (with danger symbol) Slight possibility of injury.
 WARNING	WARNING (with danger symbol) In a dangerous situation a serious accident is possible with the possibility of injury or death.
 DANGER	DANGER (with danger symbol) In the event of an accident immediate danger of death or serious injury.

2.3 Markings on Device

Safety relevant information is identified on the device using the following symbols:

	<p>Danger of Being Crushed</p> <p>This symbol warns the user of potentially being crushed (near railings, near the ramp, near dynamic support cranks).</p>
	<p>ELVETA Emergency Lowering</p> <p>The ELVETA is equipped with an electrical switch for the emergency lowering system. The emergency lowering system switch ensures that the unit is lowered in the event of a failure in the electrical lifting and lowering support (hand switch or directly on the lift).</p>
	<p>WARNING: Risk of injury by stretching the patient in gradient operation. When lowering the treadmill during operation, during a power outage and when turning off, always track the Rope length to the body weight support.</p>
	<p>Read instruction manual and follow! Read these instructions carefully before beginning any work on the treadmill! It is a part of the device and must be kept accessible at all times and in the immediate vicinity of the treadmill for operating and maintenance personnel.</p>

2.4 Personnel Qualification and Responsibility

WARNING

Danger Due to Improper Use!

Improper handling of the device can lead to serious personal injury and property damage.

- ▶ The device may only be operated by persons who have received instructions from qualified service personnel.
- ▶ **WOODWAY** recommends the use of a training record (see appendix) for proof of instruction.

Representative: *The representative is the person or company that is responsible for setting up, use and maintenance of the device.*

The representative of the device is responsible for the regular maintenance and testing as required by law. They are also obligated to provide adequate training/instruction to the operating personnel. **WOODWAY** recommends the training be carried out by trained and authorized **WOODWAY** dealer or service partner.

Operator: *Operators of treadmills for medical applications are persons who use the device and have the "power of control" over the device. This can be e.g. therapists, sports physicians or any other supervisors. The operator of a medical device is any person who - regardless of their qualifications - independently uses a medical product in the commercial sector.*

The operator is personally responsible for the safety of the user (e.g. patient, test subject). Due to the high degree of responsibility, these persons have a special obligation to provide information on all aspects of safety of the device and its intended use.

For further information on the national regulations for the use of this device, contact your authorized **WOODWAY** dealer.

2.5 Intended Use

WARNING

Danger from Improper Use!

Any improper use and/or other use of the device can lead to dangerous situations with significant personal injury and/or property damage.

- ▶ Only use the LokoStation for its intended use.
- ▶ Read and strictly adhere to all information in the operating instructions.

The LokoStation is a static/dynamic body weight support system with two-point suspension which is used for manual locomotion therapy.

The purpose of the LokoStation is to support treadmill training for:

- The therapy of patients with walking difficulties with cerebral, spinal, neurogenic, muscular or osseous causes.
- Automated locomotion therapy.
- Walking load diagnostics.
- Diagnostics for occupational medicine.
- Post-traumatic and post-operation rehabilitation.
- Orthopedic rehabilitation.
- Conditions after sudden arterial incidents.
- Ergometric examinations.
- Walking analysis.
- Fitness exercising.
- Mobilization of clients in pediatrics.

The operating instructions are an integral part of the device and are to be available to all users at all times. The exact observance of the instructions is a prerequisite for the intended use of the **WOODWAY** device.

Special User Groups!

Special attention must apply to these user groups. Compared to treadmill exercise with healthy people the risk of injury is considerably higher with these users. Strict adherence to and compliance with all safety instructions and operating information is the highest priority.

The patient may only use the treadmill and the body weight support system under the supervision of a physician and/or therapist! The training program must be medically prescribed and monitored.

WARNING

Risk of Injury Through Increased Risk of Falling!

Because of their illness or their physical/mental condition certain people have of an increased risk of falling.

- ▶ Use of a fall protection system, support belt, body weight support system (partial or complete).
- ▶ The manufacturer is not liable for personal injury and/or property damage, which could have been prevented through the use of a fall protection system, support belt or body weight support system.

Safety

ATTENTION

Claims to the manufacturer of any kind due to damage from improper use are excluded.

The representative alone is liable for all damages resulting from improper use!

2.6 Unauthorized Modes of Operation

The LokoStation may only be used for the aforementioned purpose. Any additional uses may result in serious personal injury and/or property damage.

The following restrictions and prohibitions must be strictly adhered to:

- The LokoStation may not be used without prior instruction by qualified personnel.
- Children may not use the device or be left near the device unattended.
- The use of the LokoStation under the influence of alcohol or drugs and/or narcotics is prohibited.
- The lifting of objects with the LokoStation is prohibited.
- The body weight support system may not be used on animals!
- The operation of the LokoStation outside of the named ambient conditions in the section "Commissioning" (temperature, humidity, air pressure) as well as outdoors, i.e. outside of closed rooms is not allowed.
- When being used in conjunction with a treadmill, the Safety Instructions in this manual must be observed.

The following restrictions also apply:

- Never jump on the moving belt!
- Never jump off while the device is moving!
- Never jump off of the front!
- Never stop walking when the belt is moving!
- Never turn around when the belt is moving!
- Never walk sideways or backwards (even if authorized by a physician)!
- Never set the stress level (speed) too high!

2.7 Contraindications

The application of a body weight support system during treadmill training is not useful in every case.

The LokoStation may not be used when:

- Body weight exceeds 160 kg.
- Osseous instability (non-consolidated fractures, unstable spine, severe osteoporosis)
- Open lesions in the torso area
- Circulatory instability
- Cardiac contraindications
- Excessive attention deficit disorder
- Patients with aggressive behavior
- Patients with (permanent) infusions
- Patients on a breathing apparatus
- In general, patients with prescribed bed rest or immobilization, for example osteomyelitis or other inflammatory/infectious diseases
- Hip, knee and ankle arthrodesis

The attending physician and competent therapist are responsible for assessing the therapy capability and thus for making individual decisions for each patient, determining possible risks and side effects of therapy compared to their benefits.

Medicine as a scientific discipline is subject to constant change with new insights and progress. It is the responsibility of the physician to constantly adapt their knowledge and to acquire new knowledge in the progress of therapy using the latest scientific literature. The technically-related contraindications are absolute and therefore do not fall under the decision making authority of the physician or therapist.

2.8 Safety Requirements for Patient Harnesses

The following instructions are to be observed for the safe use of patient harnesses:

- Never use the patient harness differently than described in the operating instructions.
- The harness may only be used under the supervision of trained nursing and support staff.
- The nursing staff (operator) must have the necessary expertise to select and use the appropriate harness.
- Check that the correct harness size and shape is used with respect to the patient and use only the prescribed harness.
- Ensure that the harness is not too large for the patient. Otherwise there is a danger that the patient will slip out of the harness.
- Only use prescribed carabiners.
- Check for safe condition of the harness before using it. The material must not be torn and the seams must not be damaged.
- Never leave the patient hanging unattended in the harness.
- There is a danger of being crushed during use.
- The maximum recommended load may not be exceeded.
- When choosing the size and shape the harness the weight, the size and patient's physical abilities should always be considered.
- Always ensure that the harness is properly fitted. Never leave the patient in the harness unattended.
- When the patient is obstructed by additional devices such as probes, catheters, etc., and/or is taking mind-altering drugs it is absolutely necessary that the use of the patient harness is approved by the attending physician.
- For patients with decreased sensitivity or decreased pain threshold the use of the harness is only permitted under a physician's direct supervision. The decision to use the harness must be made by the physician.
- To avoid direct contact with the harness material, the patient must be properly covered / dressed before use.
- The harness cannot be used on patients with skin diseases or other infectious diseases.
- If the patient develops nausea, dizziness, chest or joint pain the treatment is to be stopped immediately.
- Persons may not be in the immediate vicinity of moving parts.
- Before the patient is lifted, ensure that the rings on the patient harness are hanged in the appropriate lifting mechanism hooks above the patient's shoulders.
- Maintenance and repair work may only be performed by qualified professionals!

2.9 Electromagnetic Compatibility (EMC)

It is expressly noted that ELECTRICAL MEDICAL EQUIPMENT is subject to special precautions regarding electromagnetic compatibility (EMC). They must be installed and operated accordingly. It should be noted that portable and mobile RF communications equipment and other devices with interference beyond the permissible values can affect the electronics of the treadmill.

The manufacturer guarantees that the unit complies with the EMC requirements only when using the original accessories. The use of other accessories may lead to increased emission of electromagnetic interference or to a reduced resistance against electromagnetic interference.

The device must not be placed directly next to or stacked with other equipment. If such an arrangement is nevertheless required together with other devices, the device must be observed to check its intended operation in this arrangement.

Additional EMC information can be found in Chapter 11 page 60 "Guidance and Manufacturer's declaration" of this user manual.

ATTENTION

The separate operating instructions of the treadmill used must be considered when using the LokoStation!

Technical Data

3 Technical Data

3.1 Name Plate

The nameplate contains the device's main technical details.

Keep Handy for Questions!

For service questions, the technical information on the nameplate must be kept handy.

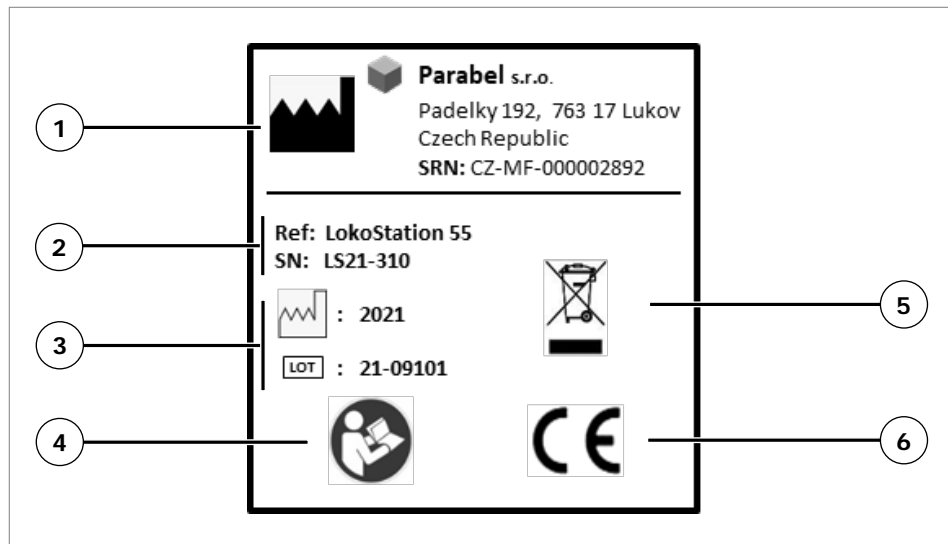

Fig. 3 Nameplate, LokoStation

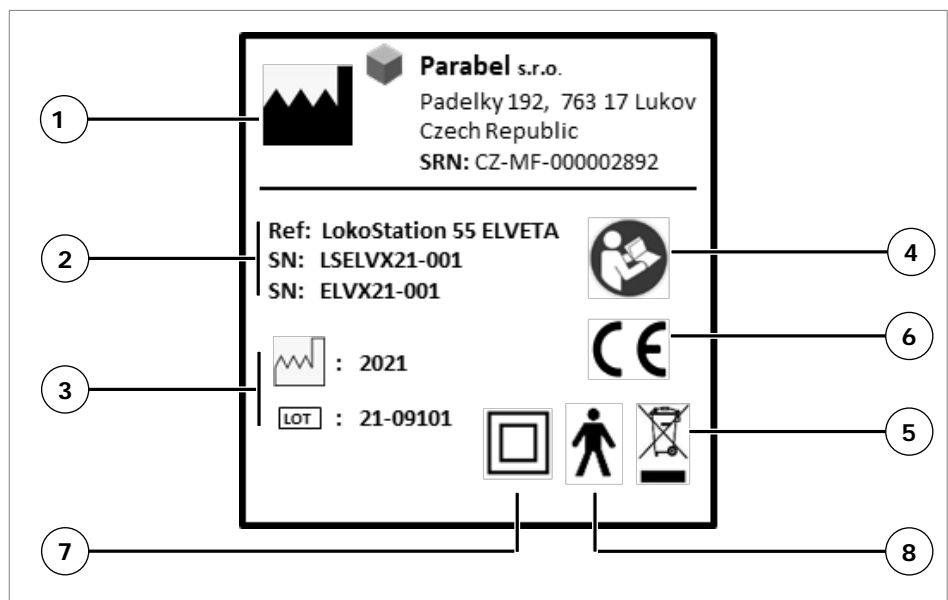

Fig. 4 Nameplate, LokoStation ELVETA

1. Manufacturer logo, name, address and SRN
2. Serial number, specify model/type
3. Year manufactured, Production lot
4. Note to read and observe the operating instructions!
5. Disposal note
6. Device CE symbol

Technical Data

- 7. Specifying the safety class, the equipment ELVETA option are electrical devices of protection class II
- 8. Electrical equipment with usable part of B type, level of protection against electric shock (in accordance with European standard EN 60601-1: 2006)

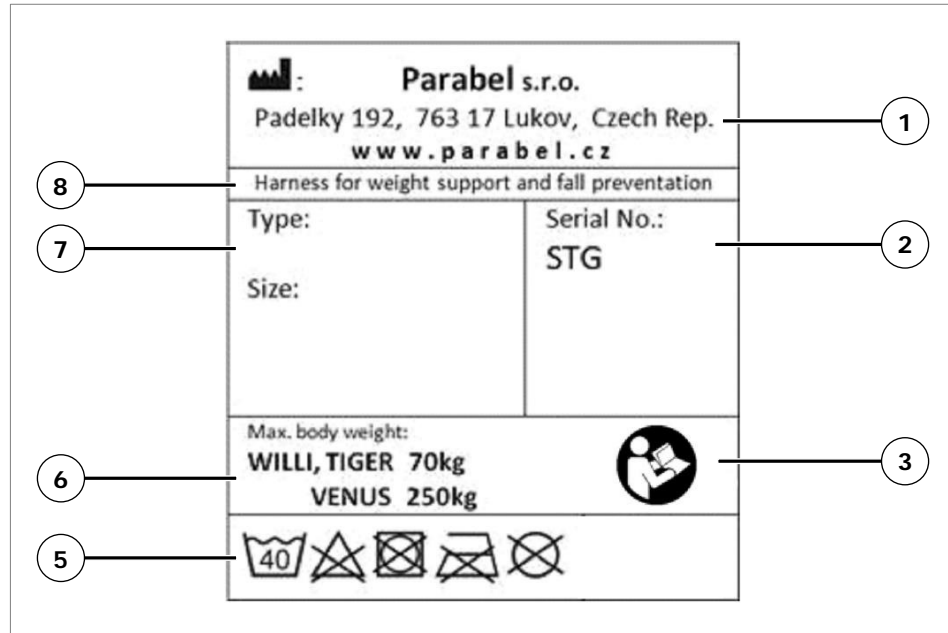

Fig. 5 Nameplate, Patient Harness

- 1. Manufacturer name, address and logo, website
- 2. Serial number
- 3. Note to read and observe the operating instructions!
- 4. Cleaning, washing and care
- 5. Maximum allowable weight
- 6. Harness tape and size
- 7. Product description

Technical Data

3.2 Dimensions and Weights

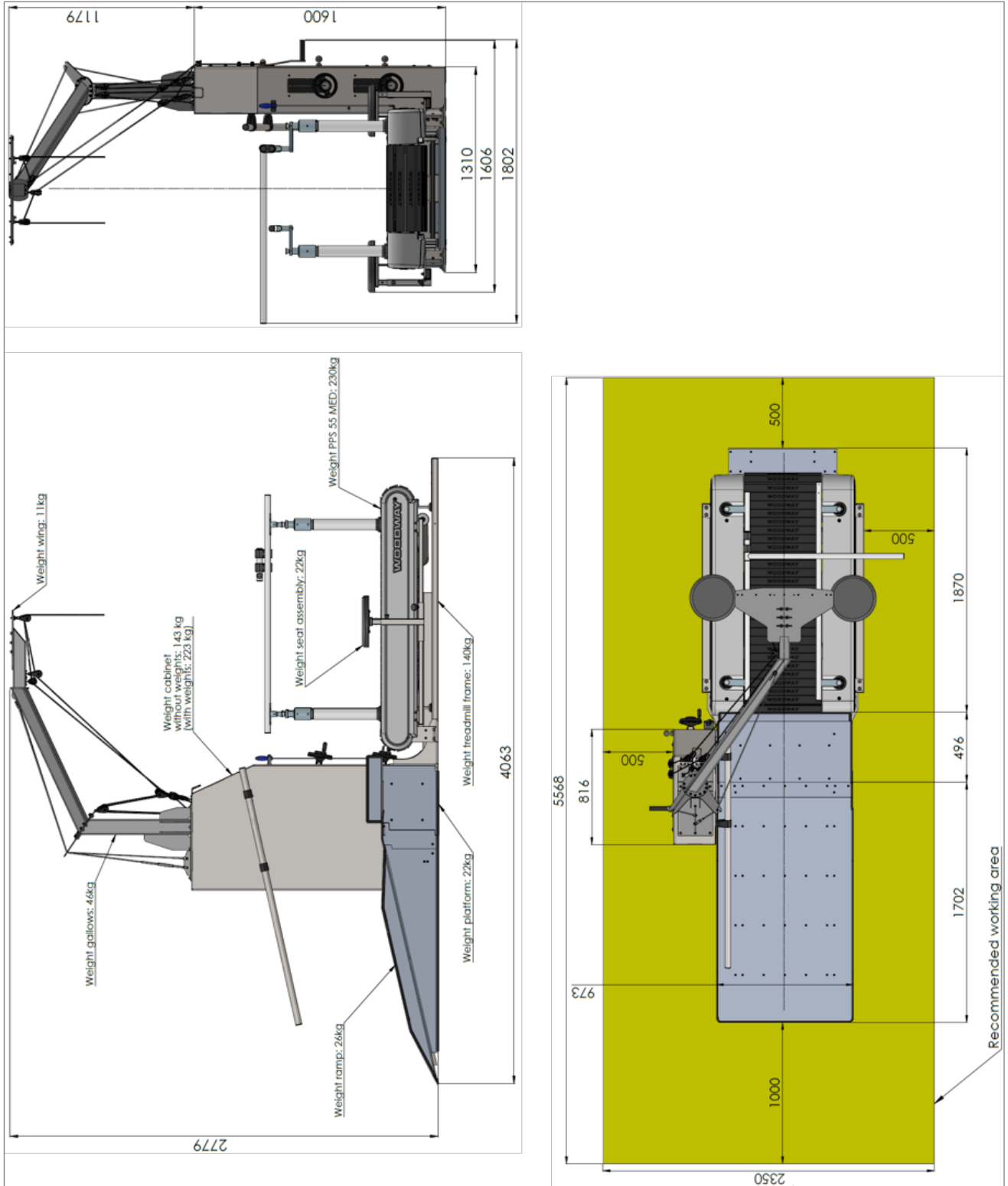

Fig. 6 Dimensions and Weights

Technical Data

3.3 Technical Specifications

3.3.1 LokoStation

Specification	Value	
Outer dimensions	LokoStation 55: 366 cm (L) x 149 cm (W) x 278 cm (H)	LokoStation 70: 366 cm (L) x 164 cm (W) x 278 cm (H)
Movement space, on all sides	0.5 m	
Weight *	450 kg (without treadmill)	
Base	Surface support frame/case	
Device color	white	
Max. patient weight	160 kg	
Dynamic weight support	2 x 38 kg	
Minimum ceiling height	285 cm	
Suspension points	2 point suspension	
Support	Symmetric and asymmetric support	
Therapist seats	2 seats, horizontal to walking surface, adjustable	
Front handrail	Movable crossbar	
Hip stabilization	2 elastic belt for stabilizing the patient's hips	
Patient harness	1 harness, including size selection	
Weight indicator	2 weight indicators for the left and right sides of the body in dynamic mode	
Access to patient	From all sides	
Wheel Chair Ramp:		
Length	177 cm	
Incline	13° (approx. 23%)	
Operating Conditions		
Temperature	10° - 40°C	
Relative humidity	15 - 85% (not condensed)	
Air pressure	700 - 1060hPa	

* *The total device weight can increase with additional equipment options.*

Technical Data

3.3.2 ELVETA Lift Motor

Specification	Value
Power supply	230VAC / 50-60Hz
Current consumption	max. 3,2 A / 230 V/AC
Classification **	Protection class II Applied part of type B Degree of protection against ingress of water: IP2X
Power supply cable	The green-yellow (Europe) / green (USA) wire in the Power supply cable is only a function earth.
Outer dimensions (lift motor only)	33,2 cm (L) x 15,6 cm (B) x 22,4 cm (H)
Weight (lift motor only)	21,5 kg
Power failure protection	internal, battery pack; 2 x 12V; 2,2Ah; 20HR
Max. stroke/lowering speed	0.03 m/sec
Fuse	T10A / 5x20
Max. patient weight	160 kg
Safety standard	EN 60601-1, EN 60601-1-2, EMC

** *Classification EN 60601-1*

4 Transportation and Storage

4.1 Safety Notices for Transportation

Check the LokoStation for damage upon arrival. Also check and compare supplied accessories with the corresponding delivery note.

WOODWAY is not liable for damages and missing parts if this information was not recorded in writing on the delivery note upon delivery of the unit. Damage or defects must be reported to the carrier and to the responsible **WOODWAY** dealer immediately.

WARNING

Risk of Injury by Machine Falling Over!

Improper transportation of the device may lead to it falling over and causing injury or equipment damage.

- ▶ Only transport in compliance with the safety regulations.
- ▶ Carry the device with at least four persons.
- ▶ Ensure stable center of gravity and steadiness in all described modes of transportation.

WOODWAY Service: If necessary, transport or relocation can be carried out by authorized **WOODWAY** service partners.

For further information please contact **WOODWAY** customer service.

4.2 Transport Notice

The LokoStation can be easily transported on a flat surface using **two** flat transport dollies (commercial transport dollies with 4 steerable wheels). The device weight must be considered.

If the LokoStation and the treadmill have to be disassembled, the covers and railings can be dismantled for easier transportation.

For a more extensive move, we recommend contacting **WOODWAY** customer service.

4.3 Storage

The device may only be stored in closed, dry rooms. It is absolutely necessary to prevent contact with moisture (rain, fog, etc.)

The following environmental conditions are prescribed for transportation and storage:

- Temperature: -10°C to +70°C
- Relative humidity: 15 - 85% (not condensed)
- Air pressure: 400 - 1060hPa

Product description

5 Product description

5.1 Main Components

The following figure shows the main components:

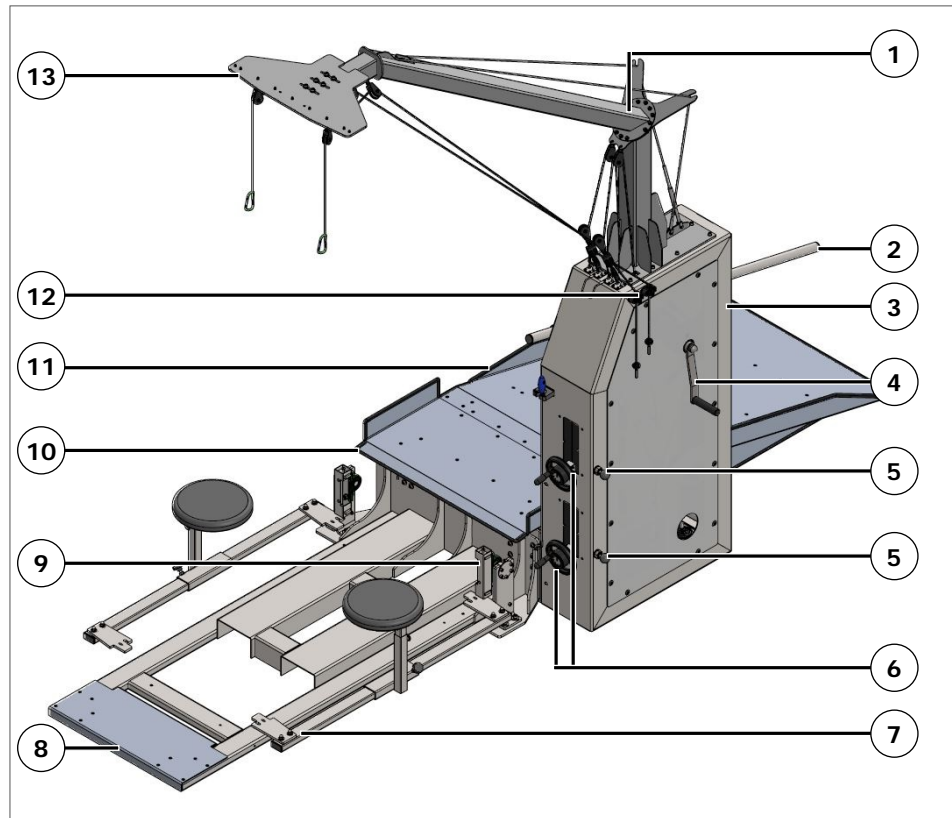

Fig. 7 Device Components

1. One arm design
2. Ramp handrail
3. Weight support housing
4. Main winch (static mode), with LokoStation ELVETA electric lift motor
5. Locking pins for dynamic body weight support mode
6. Body weight support cranks (dynamic mode)
7. Therapist Seats (attached to WOODWAY treadmill)
8. Treadmill frame, substructure
9. Pivot point displacement
10. Wheel chair platform (optional)
11. Wheel chair ramp
12. Rope length adjustment (variations possible)
13. Wing

5.2 Function Description

During the patient's gait cycle the center of gravity moves in a sinusoidal curve. Depending on the therapy requirements the body weight support system provides for either static or dynamic weight relief.

Static Body Weight Support

With static body weight support the height of the support ropes is fixed. Due to the lowering of the center of gravity during the gait cycle, the patient carries more of their own body weight in the standing phase than in the swing phase.

Dynamic Body Weight Support

With dynamic weight relief the preset support weight provides for uniform support throughout the entire gait cycle, since the support weight always follows the vertical movement of the body's center of gravity.

NOTE

Patient Note!

Patients who cannot stand on their own or who feel insecure using the dynamic body weight support should use the static body weight support.

A requirement for using dynamic body weight support is that the patient can stand on their own with no outside help.

The ELVETA Lift Motor

The hand winch for raising and lowering the patient is replaced by an electric lift motor.

The vertical movement is controlled by the motor.

NOTE

The device has no switch which separates it completely from the mains. Therefore the power plug must be pulled to disconnect from the mains.

The unit has to be set up that the plug is easily accessible.

Product description

5.3 Patient Harness

Patient harnesses serve to support body weight and to prevent falls. The body-weight support unit allows the patient to be suspended in a vertical position while maintaining the maximum possible leg mobility. The entire weight of the suspended person can be supported by the body weight support unit and the load on the legs can be increased or decreased. The leg mobility at the hip, knee and ankle area is maintained without significant restriction.

For the LokoStation harnesses are available for adults in five sizes and for children in different sizes.

	Model VENUS - for Adults -	S	M	L	XL	XXL
	Chest (cm)	70-82	80-108	100-124	120-138	139-150
	Waist (cm)	60-68	65-90	85-109	105-117	120-150
	Hips (cm)	88-90	90-112	110-128	125-140	125-150
	Max. body weight	250 kg				
	Model VENUS "WILLI" - for Children					
	Chest (cm)	67 - 75				
	Max. body weight	70 kg				
	Model VENUS "TIGER" - for Children					
	Chest (cm)	43 – 65				
	Max. body weight	70 kg				

Product description

- Fixing Straps** For the optimum body weight support device function it is important that all fixing straps on the patient harness are tightened firmly as possible. The tightening of the straps must not cause restrictions in movement.
- Harness Size** The belt size is to be adapted to the patient's body size and weight. See table below. The patient harness shoulder straps allow for correction of the person's vertical axis in the forward or backward direction depending on the therapy.
- Elastic Bands** For walk training on the treadmill the suspended person can be fixed with the supplied elastic bands. These serve to reduce the degree of freedom of movement in the hip area. The elastic bands are fixed in front of and behind the patient from one side of the railing to the other. If the person is not fixed, this can lead to uncontrolled vibrations of the suspended body.
- The patient harness can be applied in both the standing and sitting positions (e.g. wheelchair).

Commissioning

6 Commissioning

6.1 General

Commissioning is the initial intended use of the device, see sec. 2.5 Page 14. Ensure that the conditions applicable to basic safety and health requirements are met. Read these operating instructions completely before commissioning.

Before commissioning the device and suspending a patient, operating and functional safety is to be tested. This includes correct installation and operator instruction. Before commissioning, ensure that all parts are properly and securely attached to the patient harness.

6.2 Installation

ATTENTION

Consider Ceiling Height During Installation!

Before installing the device check that the room ceiling height is at least 2.85 m!

The installation and assembly of the LokoStation body weight support may only be carried out **WOODWAY** or by an authorized dealer/service provider. Otherwise shipping damage or improper installation and assembly could cause a hazard when using the device.

ATTENTION

Prepare a Stable Surface

Before the device is installed the surface must be prepared. The total weight of the device is to be considered.

- ▶ Prepare a stable and sturdy surface.
- ▶ Only install the device on a level, stable and sufficiently sturdy surface.
- ▶ If necessary, install an additional base plate/floorboard.

The following further instructions for installation are to be observed:

- When installed on upper floors, the device must be placed as far as possible in a corner of the room so that sufficient stability is guaranteed, even at max. speed. The structure of the building must be checked in advance.
- The installation surface must be flat so that there are no shear forces on the frame. Due to the weight of the LokoStation with a treadmill (depending on the device about 800 kg), the ceiling or floor must have the necessary load bearing capacity or the station must be installed near a support point. If necessary, a structural engineer should be consulted.
- Due to the moving parts on the underside, the device must not be placed directly on thick carpeting. In this case a mat should be placed under the device. This will prevent lint from entering into the device and at the same time reduce carpet wear.
- For further information on installing the LokoStation please refer to the treadmill operating instructions.

7 Operation

ATTENTION

When using the LokoStation with a treadmill, the treadmill must be equipped with an additional locking brake.

It should be noted that the braking behavior changes due to the additional brake, i.e. the braking performance is slightly "harder". One must become accustomed to the changed braking behavior!

7.1 Wheel Chair Ramp

The patient is moved onto the treadmill via a ramp or moves under their own power. When using the wheelchair ramp is particularly important to ensure that no hands, clothing, hair, or other objects become caught in the running surface. The ramp should not directly touch the running surface as this may damage the unit.

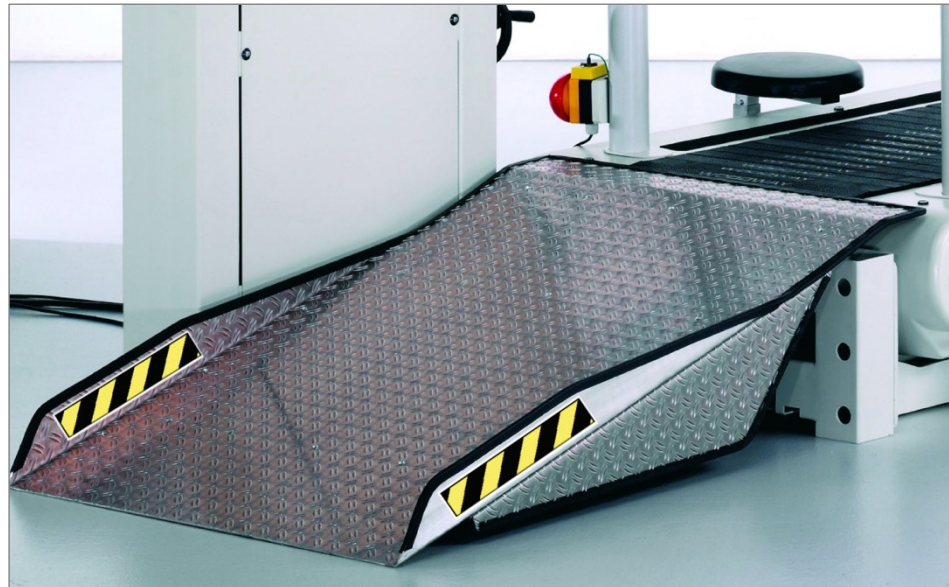

Fig. 8 Wheelchair Ramp

It is important to ensure that the wheelchair does not roll off of the side of the ramp. Only use original WOODWAY wheelchair ramps that are designed for use with the LokoStation.

ATTENTION**Before Using the Ramp Ensure:**

- ▶ That there are no tripping hazards on the ramp.
- ▶ Appropriate footwear is worn, so that persons do not slip on the ramp.
- ▶ Suspension system carabiners (weights) can cause head injuries.
- ▶ When positioning patients (especially patients who cannot stand) on the running surface, two therapists must be available. One therapist operates the cranks and one therapist helps the patient to stand up.
- ▶ The therapist seat must lock into place.
- ▶ The width adjustment must be locked into place.
- ▶ Secure the wheelchair on the ramp by fixing the brake.
- ▶ When positioning and removing the patient the running surface must be standing still.

For Performance Tests Ensure!

During performance tests or intense-interval or sprint training (Treadmill with LokoStation) additional runner safety is to be provided (Since the ramp is in position there is no fall area behind the treadmill so the additional locking brake is to be used). For this application WOODWAY requires the use of the optional fall protection (chest strap for runners suspended in the LokoStation) in order to minimize the risk of injury.

For more information see the PPS series operating instructions.

7.2 Suspension Rope Width Adjustment

The width of the suspension ropes is to be adjusted according to the patient's physical condition.

The width adjustment is made using the provided adjusting hook. It is fixed to the side of the housing.

The pulleys for the suspension ropes are located on the underside of the wing. These can be moved along the guide rail. The width adjustment is to be made as follows:

1. Using the winch (with LokoStation ELVETA remote control), let the suspension ropes down to the patient's approximate shoulder height.
2. Move the patient directly under the suspension ropes and attach the carabiner to the harness.

NOTE

The first two suspension rope pulleys (coming from the harness and mounted on the wing) are to be adjusted to match the width of the patient's shoulders. When setting the width ensure that the ropes are not under tension.

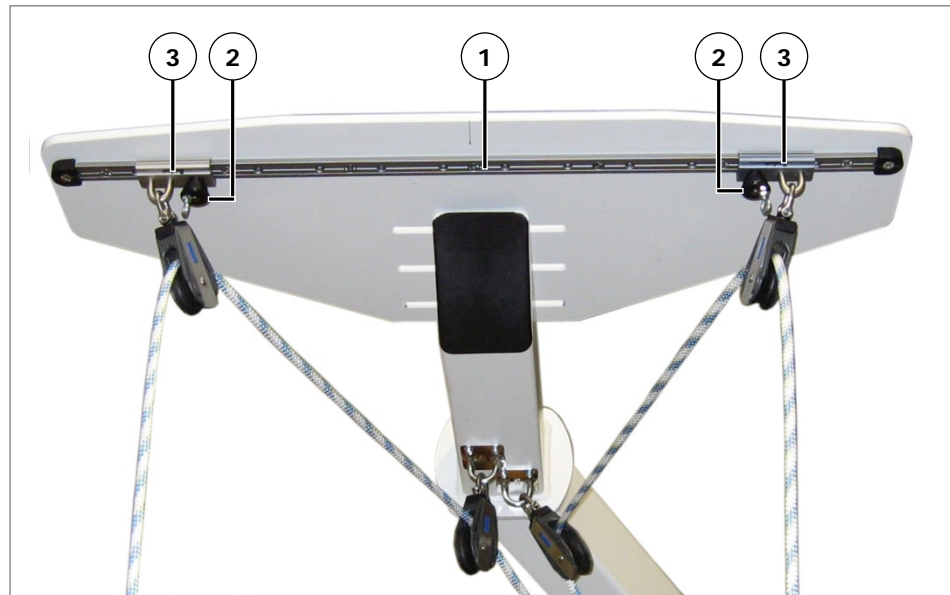

Fig. 9 Rope Width Adjustment

3. Pull the adjustment knobs (Pos. 2) on the right and left down using the adjustment hook. The knob is then pulled out of the locked position, and the sliding brackets with the pulleys (Pos. 3) can be moved freely along the guide rail (Pos. 1).



Fig. 10 Adjusting the Width

4. After positioning the pulleys in the desired position the adjustment knobs must be locked into position in one of the holes in the guide rail.
5. After making the width adjustment, the adjustment hook is to be fixed in its prescribed position on the side of the housing so as not to cause an accident during therapy (tripping etc.) The adjustment is then completed.

NOTE

The width setting on the wing is to be as symmetric as possible to ensure even weight distribution.

Operation

7.3 Body Weight Support**7.3.1 Static Body Weight Support**

When using the static body weight support the dynamic body weight support is to be deactivated using a locking mechanism as follows:

For this push both adjustment wheels completely to the bottom. Then insert both locking pins (Pos. 1) into the weight guide rails. This prevents the dynamic weight guide rails from moving.



Fig. 11 Locking Pins, Body Weight Support

The ropes are raised and lowered by turning the main crank.



Fig. 12 Main Winch Crank

- Clockwise rotation: Ropes are raised
- Counter-clockwise rotation: Ropes are lowered

Safety Mechanism! The main winch crank must be held tightly while making the adjustment. If the crank is accidentally released it is equipped with a self-locking mechanism for safety reasons.

NOTE
<p>The rope should only be wound under light tension!</p> <p>The hand winch must lock itself! During cranking the corresponding "click sound" must be audible. Optically and mechanically ensure that the hand winch is engaged.</p>

ELVETA In the LokoStation ELVETA, the hand winch for raising and lowering the patient is replaced by an electric lift motor. The unit is controlled using the remote control.



Fig. 13 ELVETA Remote Control

1. "Lift" button:
The patient is lifted/relieved and the ELVETA switches off automatically at the maximum height.
2. "Lower" button:
The patient and the ELVETA stops and switches itself off automatically at the maximum rope length.

For further information on ELVETA operation, see section 7.4 page 36.

7.3.2 Dynamic Body Weight Support

The patient must be able to stand in order to use of the dynamic body weight support!

To switch from the static body weight support to the dynamic body weight support, the patient must first be raised with the help of the central winch so that they can carry their own weight.

To enable the subsequent removal of the locking pins the ropes may not be under tension. After the patient is standing on their own, loosen the ropes slightly by turning the main crank counter-clockwise (press ELVETA "LOWER" ↓ button).

NOTE

To this point the body weight support system is still in static mode, meaning the locking pins are still in position.



Fig. 14 Preparing the Dynamic Body Weight Support

1. Locking pin inserted on right side
2. Locking pin inserted on left side
3. Dynamic body weight support crank, left side of body
4. Dynamic body weight support crank, right side of body

The desired weight support is separately adjusted for each side of the body using the two dynamic body weight support cranks.

Support Weight

If the dynamic body weight support cranks (Pos. 3 and 4) are turned clockwise to the stop (press ELVETA "LIFT" ↑ button), a maximum dynamic support weight of 38 kg per body half is set.

By turning the crank counter-clockwise the dynamic body support weight can be reduced to a minimum of 4 kg per side (press ELVETA "LOWER" ↓ button). With the upper crank the weight support for the right half of the body is adjusted and accordingly with the lower crank the weight support for the left half of the patient's body is adjusted.

Activating the Dynamic Body Weight Support

The dynamic body weight support is activated by removing the locking pins. To facilitate removing the pins rotate the crank slightly. The removal of the locking pins allows the movement of the weight guide rails, thus activating the dynamic weight support.

By locking the upper or lower weight guide rail, dynamic weight control can be combined with static weight control.

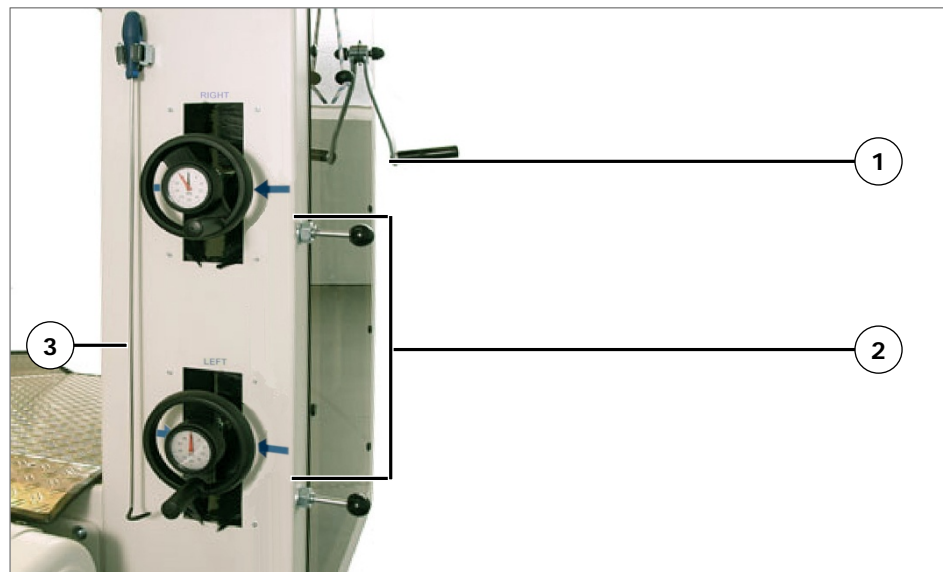

Fig. 15 Adjusting the Dynamic Body Weight Support

1. Main winch
2. Weight guide rails centered in the adjustment range.
3. Adjustment hook for width adjustment

Preparation: Crank the patient higher in static mode (more support). Pre-adjust the weight for dynamic support and then remove the static support locking pin. Readjust if necessary.

Turn the central winch clockwise (press ELVETA "LIFT" ↑ button) until the two weight guide rails (Pos. 2) are centered within the adjustment range, and thus have room to move up and down.

If necessary, the dynamic body support weights can be adjusted during therapy using the two cranks (press ELVETA "LIFT"/"LOWER" button).

If therapy with dynamic weight support is ended, rotate the central winch crank counterclockwise as with static weight support (press ELVETA "LOWER" ↓ button). This lowers the dynamic weight guide rails to the lowest position in the adjustment range. Now reinsert the locking pins.

The body weight support system is returned to static support mode.

7.4 The ELVETA Lift Motor

In the LokoStation ELVETA, the hand winch for raising and lowering the patient is replaced by an electric lift motor.

 WARNING
<p>Danger in gradient operation of the treadmill!</p> <p>Risk of injury by stretching the patient in gradient operation. When lowering the treadmill during operation, during a power outage and when turning off, always track the Rope length to the body weight support.</p>

Operation

7.4.1 Function

The lift motor performs the vertical movement in both directions. The included power adapter (in the LokoStation box) serves the power supply. The lift motor is also equipped with batteries. The batteries are intended for the lowering of the patient during a power outage. At underrun the voltage limit (deep discharge) the battery provides an emergency lowering.

The user is informed by an interrupted sound that the batteries need to be re-charged. When the batteries are empty or an error has occurred, a sound and the red LED "LOW BATTERY" will light.

7.4.2 Remote Control

The unit is controlled using the remote control.

Display Before each use, check that the green LED "POWER" is illuminated on the drive. If not, check the power supply or turn off the power supply for one minute.

ATTENTION

For safety reasons and to ensure proper function, the ropes and the motor belt must always be under slight tension during lifting and lowering operations.

The belt tension is monitored by a control mechanism.



Fig. 16 ELVETA Remote Control

1. "Lift" button:
The patient is lifted/relieved and the ELVETA switches off automatically at the maximum height.
2. "Lower" button:
The patient and the ELVETA stops and switches itself off automatically at the maximum rope length.

7.4.3 Power Supply (Charging the Batteries)

If the power cord of the unit is plugged in and power is applied, the green LED "POWER" is illuminated on the drive. It will recharge the batteries.

ATTENTION

It is necessary always to connect the power cable to the socket.

**Warning Signal
"Low Battery"**

The user is informed by an interrupted sound about the fact that the batteries need to be recharged. When the batteries are empty or an error has occurred, there is a sound when lifting.

Fully discharged batteries are recharged in approximately 6 hours.

**Warning Signal
"Working on Batteries"**

When the lift motor is powered by the batteries (power supply not connected) and the batteries are charged, a repeating short beeps alarm would be triggered.

ATTENTION

It is recommended to replace the batteries every six years during the annual maintenance.

7.4.4 Lift Motor Operation

Emergencies

In case of remote control malfunction, vertical movements can be controlled using the controls on the motor.



BLUE ⇔ **UP**. Patient lifting

GREEN ⇔ **DOWN**. Patient lowering

CONTROL LED = always lights up when an operator button is held down

EMERGENCY LED = lights when emergency lowering is active

LOW BATTERY LED = lights up when the battery capacity is low

POWER LED = lights up when the supply voltage is connected

Remote = Plug for remote control

Power supply = Plug for power adapter

Main Switch = When OFF, the operation does not work, the battery does charge

Fuse = Glass fuse T10AL250V (5x20 Large)

Fig. 17 ELVETA Drive, Control Elements

Operation

7.4.5 Emergency Lowering

The ELVETA is equipped with an electrical switch for the emergency lowering system. The emergency lowering system is necessary to ensure controlled lowering in case of hand switch failure or direct electric motor operation of the lifting and lowering support.



Fig. 18 Emergency Lowering Switch

The emergency lowering switch is located on the right side of the lift motor. To operate the switch, reach through the hole in the Plexiglas window and press the red button on the right side of the lift motor. The patient will be lowered.

! WARNING

Risk of Injury Through Malfunction!

Using the emergency lowering system may lead to malfunctions in lifting and lowering operations. There is a risk of uncontrolled lifting or lowering with the risk of injury.

- ▶ **Do not use the lift after using the emergency lowering system.**
- ▶ **Contact your responsible customer service office immediately!**

7.5 Therapist Seats

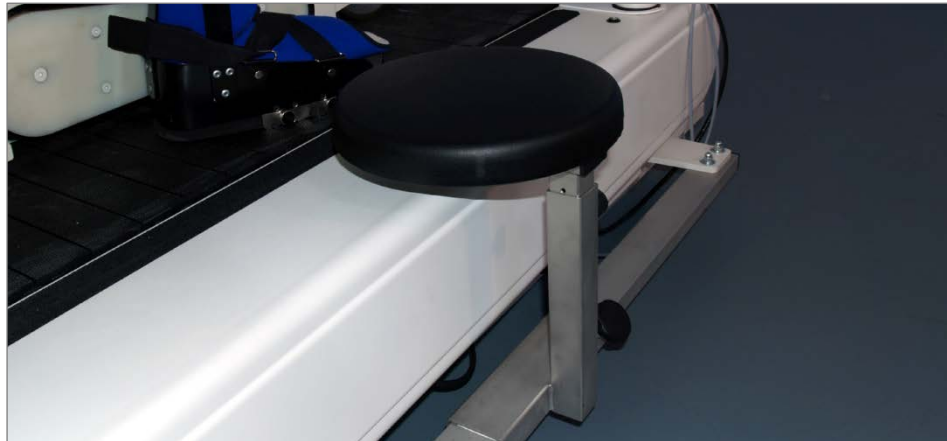

Fig. 19 Therapist Seats

The therapists' seats are located on the side of the treadmill and can be adjusted in height and horizontally as needed.

Loosen the locking knob and retighten after positioning.

7.6 Rope Length Adjustment

The cable length adjustment allows the setting of different body support heights in static weight support mode and thus an asymmetric weight support of the two halves of the body during walking.

The rope length adjustment is only carried out on one side (left). This effects a change in length relative to the right rope.

The optimum suspension setting during lifting is a central position.

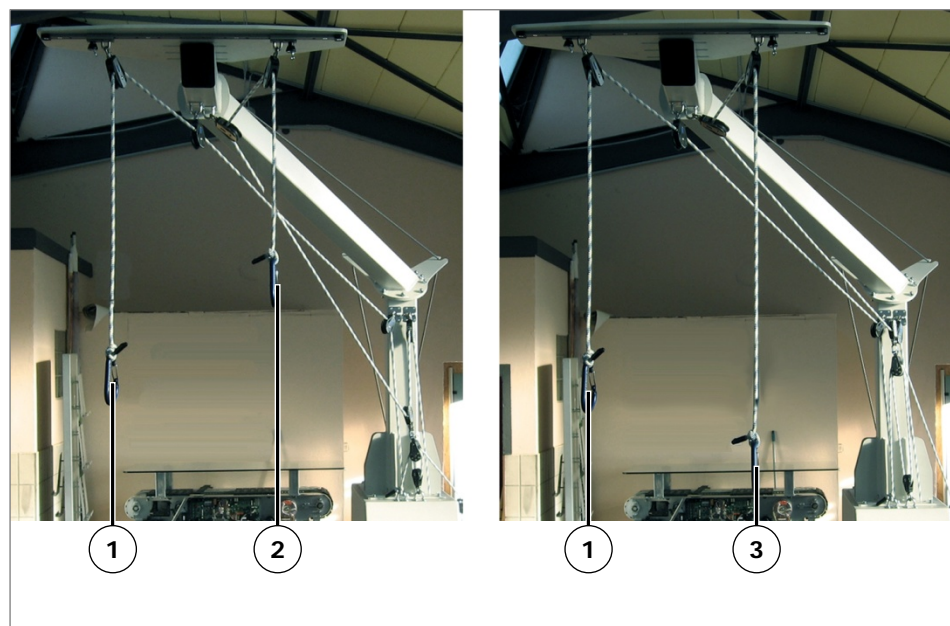

Fig. 20 Rope Length Adjustment

1. Right rope, constant length
2. Left rope, shortened length - left side of body is lifted
3. Left rope, extended length - left side of body is lowered

Operation

Adjusting the Rope Length:

The locking pins in the LokoStation are inserted, see Fig. 11 Page 33.

- Raise the patient by turning the central crank clockwise (press ELVETA "LIFT" ↑ button) until only the heel is in contact with the running surface.
- By pulling the rope length adjustment downward (Pos. 2), the left half of the body is raised above the support height of the right half of the body. By loosening the rope length adjustment (Pos. 1) the support height of the left half of the body is lowered below that of the right half of the body.

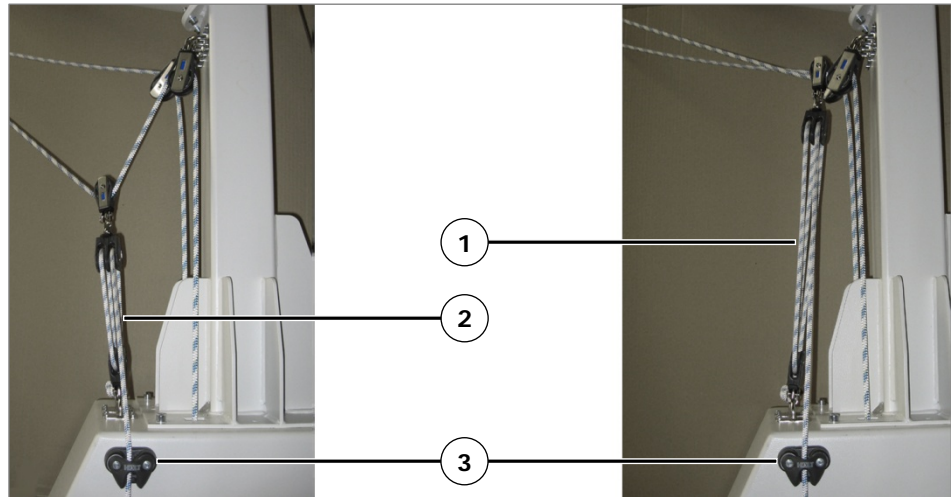

Fig. 21 Rope Length Adjustment

1. Rope Length Adjustment, Lower
2. Rope Length Adjustment, Raise
3. Rope return-stop

NOTE

The rope should only be wound under light tension!

After making the length adjustment, return the rope to the provided return-stop (Pos. 2). Hold the rope guide pulley for support (Pos. 1):

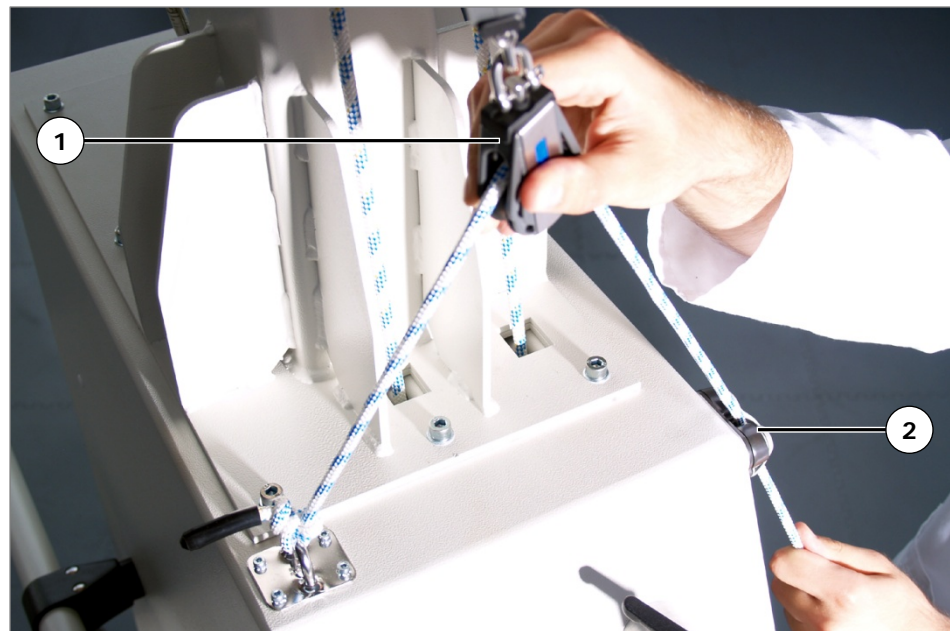

Fig. 22 Rope Return Stop

The rope is fixed in the return-stop while under tension.

7.7 ELVETA Rope Length Adjustment

The ELVETA is equipped with a two-sided rope length adjustment. This makes the change and correction of the relief geometry possible, as well as optimization of the maximum patient size.

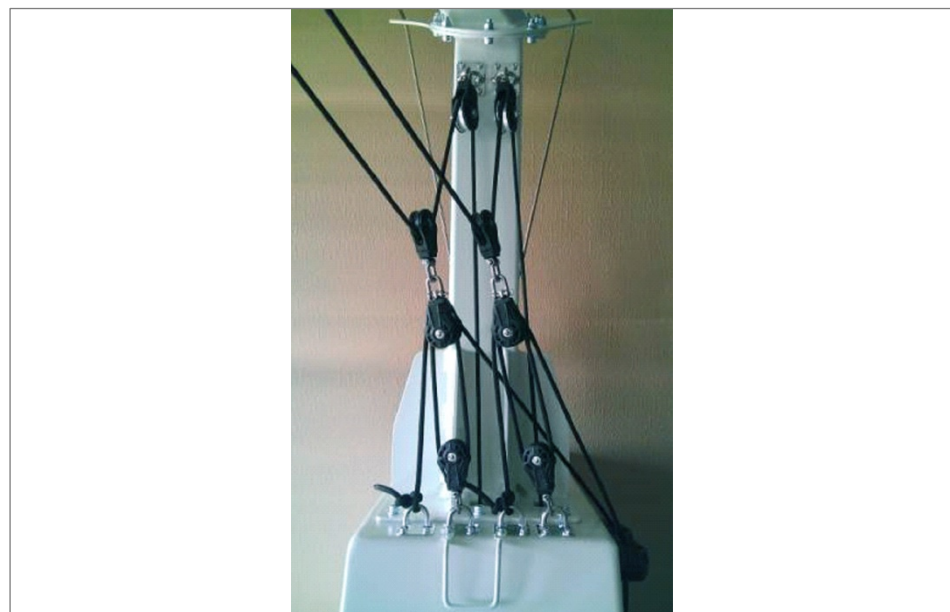

Fig. 23 ELVETA, Two-Sided Rope Length Adjustment

Operation

Using the rope length adjustment the rope length can be adjusted by approx. 40 cm.

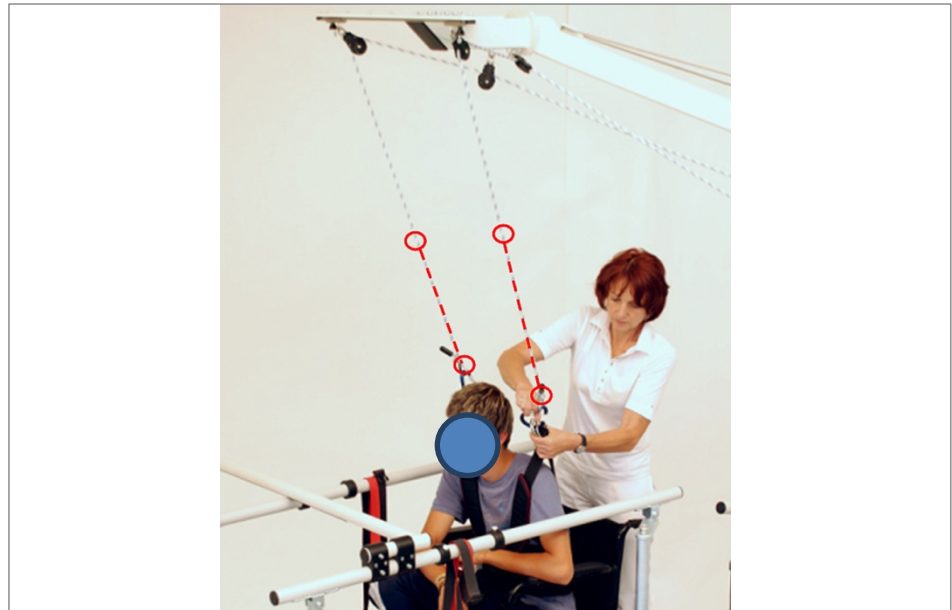

Fig. 24 ELVETA, Adjustable Rope Lengths

7.8 Patient Harness

ATTENTION

Before using the patient harness ensure that:

- ▶ The patient harness shows no signs of damage or wear.
- ▶ The straps and their couplings are mounted correctly and securely.
- ▶ A defective patient harness is never used.

ATTENTION

For optimal use it is important that the thorax belt is closed tightly. However, ensure that the patient feels comfortable and breathing is not impaired.

The lower edge of the chest strap should be about 2cm below the iliac crest and tightened.

When the thorax belt is firmly closed the pressure on the leg straps is reduced. As a result, the patient finds the body weight support to be comfortable.

7.8.1 Safety Buckles

Every VENUS patient harness has 4 steel/brass safety buckles. Each buckle can hold a vertical loaded with up to 250 kg. The closing system is specially designed to prevent unexpected opening.

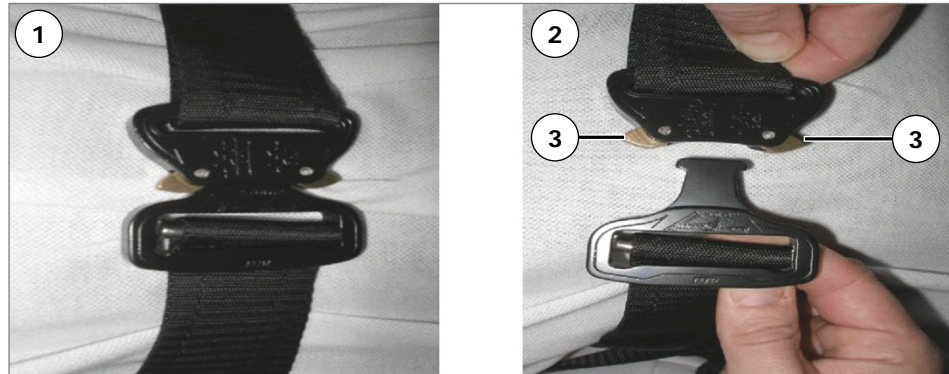

Fig. 25 Safety Belt Buckles

1. Safety buckle closed
2. Safety buckle opened
3. Locking tabs

To open the buckle unlock the mechanism by pressing the locking tabs (Pos. 3).

NOTE

Use two fingers to press the locking tabs (Pos. 3)!
It is not possible to open the buckle when it is under pressure.

Operation



7.8.2 Applying the Patient Harness

In the following description, applying the patient harness is explained using the VENUS model as an example.





For the WILLI and TIGER models proceed similarly.

NOTE



The following figures provide examples of the order of belt application. In the real case the patient's belt is applied by the attending therapist.

	<p>1. Place the harness on the upper body from the rear and slide it forward under the shoulders. Please note that the belt has an upper and lower leg pad. The harness can be applied while seated or standing. The chest strap buckles and two leg strap buckles should be opened.</p>
	<p>2. Pull the bottom of the inside belt padding. The inner padding should not be in contact with the patient's skin. The patient should wear a cotton shirt or a similar piece of clothing.</p>
	<p>3. Pull the other side of the belt padding tight and fasten with the Velcro. The belt padding should fit so tightly that it cannot slide around.</p>

Operation

	<p>4. Now close the upper and lower fasteners on the pelvic belt. If necessary, adjust the belt length to the body size.</p>
	<p>5. Slide the leg padding between the legs toward the front and close the buckles. Adjust the position of the harness and the tension of the straps according to patient disability and comfort.</p> <p>NOTE: The body weight should not be supported by the leg straps, but by the pelvis strap!</p>
	<p>6. The weight is mainly supported by the thorax element, for this reason it must be well tightened. The thorax strap must not be twisted, for buckle position see figure! Ensure that the safety buckles are securely latched.</p>
	<p>7. If the patient's condition allows it, tighten all fastening straps in standing. If it is not possible, this can be carried out after suspending the patient. Secure seating must be ensured before treatment. To achieve better pelvic extension it is recommended that the led straps be tightened in the back. Ensure in advance that the thorax strap is pulled down as far as possible.</p>

Operation

	<p>8. Ensure that the upper leg pad and leg straps are applied as shown in the figure.</p> <p>NOTE: The leg padding can be crossed between the legs or applied according to the patient's comfort. There should be no uncomfortable points where the leg straps press against the body.</p>
	<p>9. Finally, the patient is hooked with the rings into the weight support system hooks for therapy.</p>

To open the harness, proceed in the reverse order.

7.8.3 Hip Stabilization

Hip stabilization is accomplished using two elastic bands which are fixed crosswise between the hand rails.



Fig. 26 Hip Stabilization

- 1. Elastic bands crosswise, 1 x front and 1 x rear
- 2. Clamping collars with adjustment screws

Operation

There are two plastic clamping collars on each hand rail that can be released using the screw and moved on the rail for width adjustment. The clamping collars are used to position the front and rear elastic bands.

Two stable Elastic bands are placed crosswise around the patient. This minimizes hip movement and stabilizes the patient.

Positioning: The elastic bands are placed at the height of the patients hips. For this the hand railing needs to be set to the proper position. When positioning the elastic bands on the railing, it is important to ensure that an optimum distance to the crossbar is maintained. This gives the patient the possibility to support themselves in a comfortable position (see figure).

The physician/therapist determines the tension of the elastic bands according to therapeutic requirements. The tighter the bands are, the higher the stabilizing effect is.

ATTENTION

The elastic bands must be at least tense enough that they do not slip over the clamping collars! This would cause sudden destabilization of the patient!

Do not stretch the elastic bands to tight that the patient is uncomfortable or feels pain!

7.8.4 Harness Fastener

The patient is fixed to the crossbar using the harness fastener. It is fastened directly to the patient harness and the crossbar



Fig. 27 Fastening the Harness

When simulating walking on the treadmill, fix the body to the treadmill crossbar using the front harness fastener.

For this wrap the elastic fastening band with the carabiners around the front crossbar.

Options and Accessories

8 Options and Accessories

8.1 Order Numbers

The following accessories and options can be obtained from a WOODWAY dealer or WOODWAY service center.

Will the Accessories Fit?

Depending on year and equipment, it should be checked in advance whether the particular unit is suitable for the selected accessories/options.

For this contact the WOODWAY dealer or WOODWAY service center before ordering.

8.2 Overview of Accessories

Description	Specification	Order no.
Weight indicator	2 digital weight indicators for static weight support	P100118
Platform for wheel chair ramp	Level platform, 50 cm long, for extending the inclined wheelchair ramp	P100060
Longer wheelchair ramp	Wheelchair ramp with railing, 206 cm long, (incline approx. 10° = approx. 17.6%)	P100261
Longer ramp handrail	It is recommended to order it together with the platform for wheel chair ramp, handrail is 170cm long	P100275
Patient harness	Model, VENUS sizes S, M, L, XL or XXL	Des. sec. 8.4
Child harness	Model, VENUS sizes, WILLI" or „TIGER"	Des. sec. 8.4
Child handrails	Set of adaptable handrails for children	P100061
Harness fastener for front crossbar	Elastic band with two carabiners	P100018
Height reduction	Height reduction (For rooms with ceilings lower than 2.85 m)	P100245

8.3 Installation Kit for PPS Treadmill

An installation kit is available for using the LokoStation in connection with a **WOODWAY** PPS Series treadmill.

For further information please contact WOODWAY customer service directly.

8.4 Patient Harness and Accessories

Description	Order no.
Child harness, VENUS, size "TIGER"	P100016
Child harness, VENUS, size "WILLI"	P100015
Patient harness, VENUS, size S	P100011
Patient harness, VENUS, size M	P100012
Patient harness, VENUS, size L	P100013
Patient harness VENUS, size XL	P100014
Patient harness VENUS, size XXL	P100311
Inner padding for child harness, VENUS, size "TIGER" (Harness Art no. P100016)	P100306
Inner padding for child harness, VENUS, size "WILLI" (Harness Art no. P100015)	P100307
Inner padding for harness, VENUS, size S (Harness Art no. P100011)	P100304
Inner padding for harness, VENUS, size M (Harness Art no. P100012)	P100272
Inner padding for harness, VENUS, size L (Harness Art no. P100013)	P100303
Inner padding for harness, VENUS, size XL (Harness Art no. P100014)	P100305

NOTE

For special sizes please enquire with **WOODWAY!**

Maintenance and Cleaning

9 Maintenance and Cleaning

! WARNING**Danger of Injury Due to Lack of Qualifications!**

If maintenance or repairs are not carried out by professionally qualified personnel, this may cause material damage and serious injury.

- ▶ Maintenance and repair work may only be performed by qualified personnel!
- ▶ It is the sole responsibility of the representative to assign qualified personnel for maintenance and repair work.
- ▶ In case of doubt or questions, always contact the WOODWAY customer service or dealer!
- ▶ **WOODWAY** is not liable for personal injury and material damage caused by a lack of qualifications!

9.1 Cleaning

! DANGER**Danger of Death by Electric Shock!**

The use of water and liquid detergents as part of cleaning work can cause serious or fatal electrical shock when used with a treadmill.

- ▶ No liquids may come in contact with electrical parts such as motor, power cord and power switch, control monitors.
- ▶ Do not spray the device with a water jet.
- ▶ Pull power plug before cleaning, equipment must not be connected to power! Ensure the device cannot be switched back on.

The LokoStation should be thoroughly cleaned at regular intervals, depending on the intensity of use.

Remove light dirt and dust with a soft cloth. Dirt can be removed with damp cloth and mild soapy water. After cleaning dry with a dry cloth!

Cleaning Notes:

- Do not use sharp tools for cleaning. (knife, metal scraper) or aggressive solvents.
- Do not clean with a high-pressure cleaner.
- Clean all surfaces with a non-abrasive, mild detergent.
- To avoid damage to component surfaces, observe the instructions for detergent use.

Disinfection:

For cleaning and disinfection of parts that are touched a formaldehyde-free rapid disinfectant such as "Bacillol plus" or "Descosept" is recommended. For cleaning, never use sharp brushes or abrasive cleaning agents, paint and plastic surfaces can be damaged.

9.2 Maintenance Intervals

The specified maintenance intervals or the replacement of parts specified by the manufacturer must be carried out earlier if there are signs of wear.

For proper inspection and regular review, we recommend a **WOODWAY** maintenance contract.

ATTENTION

Worn or damaged components must be replaced immediately. If the observed deficiency can cause danger to the user or operator of the LokoStation, it may not be used until it is repaired.

9.2.1 Daily Maintenance

- All cable guides, pulleys and the return stop should be checked before the daily use.
- All knots and rope connections are to be checked.
- LokoStation ELVETA: The electrical functions should be checked each day before use.

9.2.2 Weekly Maintenance

- Check all ropes for wear
- Check all pulley mounts
- Check all pulleys for damage or wear
- Check all safety-relevant screw connections
- Check handrail fixation
- Clean and disinfect control elements (crank etc.)
- Clean ramp
- Clean the area under the ramp (vacuum and mop).

9.2.3 Semiannual Maintenance

- Tighten the width adjustment guide rail, or check for tightness

9.2.4 Annual Maintenance

- Replace all ropes
- Replace all pulleys
- Inspection of the entire system
- LokoStation ELVETA:
 - Replace motor belt (if necessary).
 - Electric checks and inspection in accordance with EN 62 62353
 - Inspection of safety functions

Maintenance and Cleaning

9.3 Patient Harness

 WARNING
<p>Danger of Injury Due to Defects in Patient Harness!</p> <p>Defects in the harness system can lead to serious injury caused by tripping or falling.</p> <ul style="list-style-type: none"> ▶ Check the harness regularly for damage, see section 9.3.1. ▶ If defects are found the harness is to be taken out of service and replaced. ▶ Never attempt to repair the harness.

9.3.1 Maintenance

Using the points listed below, check the condition of the fabric, seams and straps. The harness must be carefully checked by a responsible and trained person monthly, or more often depending on the frequency of use. The results of the patient's harness check must be noted on the check sheet and confirmed with a signature. The harness should also be checked by the operator before each use.

Outer Wear: This is inevitable under normal use and can be identified by a slightly downy fiber surface. This is not critical unless the area becomes too large.

Spot Wear: This can be caused by rubbing the stretched fabric over sharp edges or protrusions. Minor damage to the outer fibers can still be considered safe, but in more severe cases, particularly reduction of the width or thickness or deterioration of the fabric should result in immediate replacement of the patient harness.

ATTENTION
<p>Cuts, holes or burns in the fabric are potentially dangerous! In such cases replace the patient harness immediately!</p>

Chemical Effects: Oil, grease or paint stains are acceptable, but other types of chemical effects at a certain degree can lead to deterioration or the extreme softening of the fabric under certain circumstances. This can lead to fabric wear (like a powder in extreme cases). Avoid acid and alkali vapors, sprays or fogs and organic solvents.

Note!

In case of suspected contamination, wash the harness in warm water. Avoid contact with excessive heat, which could affect the harness under certain conditions.

Accessories: Accessories include: Carabiners, chains "D" and "O" rings, hooks, buckles etc.

Inspect the accessories carefully for ease of movement and for signs of rust, bends and cracks. Hooks and carabiners must be checked for ease of movement. The mechanism needs to open and close smoothly.

Check the buckles for easy movement and sharp edges or burrs that could damage the fabric.

Checking the Seams: Check seams for tears, wear and pulled out or torn stitching. Replace every sling with excessive abrasions or in which threads or seams are torn.

Knots and Carabiners: Knots and carabiners should be checked by the operator before each use. If a carabiner does not close, it must be replaced.

The rope end in a knot must extend at least 5 cm. If the length shortens or the knot constantly loosens, the LokoStation may not be used anymore.

Maintenance and Cleaning

9.3.2 Cleaning

The service life of the harness can be extended through regular cleaning and inspection. Operational safety is increased through regular inspections.

The harness inner padding can be washed with commercial detergent at 40° C.

ATTENTION

Velcro connections must be closed during washing otherwise they lose their ability to function.

The outer parts of the patient harness are to be wiped with a damp cloth. Machine washing is not recommended due to the metal parts as these can cause damage.

**Washing
Instructions:**

Maintenance and Cleaning

9.4 Troubleshooting

ATTENTION
<p>With the exception of the maintenance work described in this chapter, the LokoStation can only be checked and repaired by qualified personnel.</p> <p>If necessary the WOODWAY dealer or service center is to be contacted!</p>

9.4.1 LokoStation

Defect	Cause	Solution
Significant rope wear Dynamic weight movement one-sided or delayed	Defective roller, increased friction (roller blocked)	Replace defective rollers, replaced damaged ropes
Static to dynamic locking pin does not release	<ul style="list-style-type: none"> - Pin bent (allowable patient weight significantly exceeded) - Pin blocked or seized in hole 	<ul style="list-style-type: none"> - Replace pin - Grease pin slightly
Weight blocks cannot be adjusted	<ul style="list-style-type: none"> - Threaded spindle, nut locked - Slide has become loose 	<ul style="list-style-type: none"> - Repair by customer service - Repair by customer service
Winch will not lock in place Winch will not release	<ul style="list-style-type: none"> - Winch lock defective - Crank system blockage - to little play in crank limit nut 	<ul style="list-style-type: none"> - Replace, repair, maintenance by qualified personnel - Replace, repair, maintenance by qualified personnel - Readjustment according to the manufacturer information
System unstable (casing - boom - treadmill)	<ul style="list-style-type: none"> - Loose screws 	<ul style="list-style-type: none"> - System safety check - Tighten screws. - Replace screw sets if necessary

Maintenance and Cleaning

9.4.2 LokoStation ELVETA

Defect	Cause	Solution
Remote control does not function	Remote control or extension cord is damaged	Replace remote control or extension cord
ELVETA does not function, only emergency lowering	Electronics defective	ELVETA must be checked by the manufacturer or a service partner
Fuse defective	Motor has been overloaded	The maximum load of 160 kg has been exceeded
	Power supply is broken	Check the output voltage of the power supply.
Lifting/lowering does not function		<p>Check the following points:</p> <ul style="list-style-type: none"> - Is the belt (rope) under tension when the function switch is pressed? (7.4.2) - Does the green LED light on the drive (cabinet)? - Is the main switch on at the drive? (7.4.4) - Is the fuse damaged? (7.4.4) - Is the power adapter functioning? - Does the emergency lowering function? (7.4.5) - If the above points are in order, please contact your service partner
During lifting/lowering the patient drops down to a few centimeters	Button for emergency lowering was pressed without tension on the belt - belt is tangled in the motor	Unwind the belt completely and rewind it under tension
Noises occur when the emergency lowering is activated: Humming	Inadequate power supply Either the ELVETA hadn't been used for a time and the batteries have lost capacity, OR the charger is defective and the batteries have been discharged	ELVETA must be checked by the manufacturer or a service partner

Instruction Record

10 Instruction Record

Once the LokoStation/LokoStation ELVETA is delivered, installed, and a function test was carried out, instruction is to be carried out by a competent **WOODWAY** employee or the authorized **WOODWAY** dealer. All persons who will work with the device in the future must participate in the instruction. As soon as the commissioning and training have taken place, the instruction protocol must be signed by the instructor and all participants and a copy must be sent back to WOODWAY GmbH.

Step	Description	Status
1	Transfer of operating and maintenance instructions. Important Notice: The manual is always to be kept within easy reach of users! The availability of the manual is required and will be checked at each inspection.	<input type="checkbox"/>
2	Reference to the general hazard statements and safety requirements according to the manual. Thereby indication of specific LokoStation hazard statements according to area of application (benefit/risk assessment by the therapist, etc.). Assistance for Frail/Disabled Persons When Using the LokoStation.	<input type="checkbox"/>
3	Instruction in selection of the appropriate size patient harness and proof of correct patient harness application.	<input type="checkbox"/>
4	Instruction and areas of special attention in regard to the use of metal buckles.	<input type="checkbox"/>
5	Special instruction in the safe fixing of carabiners in the patient harness.	<input type="checkbox"/>
6	Instruction in the operation of the central hand winch for raising and lowering the patient.	<input type="checkbox"/>
7	Instruction in the use of the winches for dynamic body weight support.	<input type="checkbox"/>
8	Instructions on the use and operation of the ELVETA option.	<input type="checkbox"/>
9	Instruction in making the rope length adjustment.	<input type="checkbox"/>
10	Instruction in adjusting the width of the suspension ropes	<input type="checkbox"/>
11	Instruction in the adjustment (horizontal, height) of the therapist seats.	<input type="checkbox"/>
12	Instruction in checking pulleys, ropes and straps before using the LokoStation.	<input type="checkbox"/>
13	Instruction on the carrying out of maintenance in regular intervals and the cyclic exchange of pulleys and ropes.	<input type="checkbox"/>
14	Final photographs of the device from two different perspectives (Include with the instruction record).	<input type="checkbox"/>

Instruction Record

Step	Description	Status
15	<p>Explanation of possible malfunctions that must lead to a disabling of the LokoStation:</p> <ul style="list-style-type: none"> • Slipping of main hand winch (patient slides back down after lifting) • defective pulleys, rope guide rollers • damaged ropes • damaged patient harness • defective or non-existent safety equipment • Malfunctions/Defective emergency off switch • Damage to treadmill running surface • LokoStation ELVETA: Do not use the lift after using the emergency lowering system. 	<input type="checkbox"/>

Instruction Record

LokoStation/LokoStation ELVETA

Serial No.: _____

Model: _____

The above device was properly set up / installed on: _____
(Date)

Technical instruction was completed on:
_____ (Date)

Place of transfer / instruction: _____

The following persons received instructions:

(Name and function)

(Signature)

(Name and function)

(Signature)

(Name and function)

(Signature)

(Name and function)

(Signature)

Remarks: _____

(Location, Date)

Name (printed capital letters) and signature
Instructor (Medical device consultant)

Guidance and Manufacturer’s declaration

11 Guidance and Manufacturer’s declaration

ELECTROMAGNETIC EMISSIONS for all ME EQUIPMENT and ME systems

(See IEC 60601-1-2:2007, chapter 6.8.3.201 a) 3)

Emissions test	Compliance	Electromagnetic environment - guidance
RF emissions CISPR 11	Group 1	LokoStation / LokoStation ELVETA uses RF energy only for its internal function. Therefore, its RF emissions are very low and are not likely to cause any interference in nearby electronic equipment.
RF emissions CISPR 11	Group 2	LokoStation / LokoStation ELVETA is suitable for use in all establishments, including domestic establishments and those directly connected to the public low-voltages power supply network that supplies buildings used for domestic purposes.
Harmonic emissions IEC 61000-3-2	Class A	
Voltage fluctuations/Flicker emissions IEC 61000-3-3	Complies	

Electromagnetic IMMUNITY - for all ME EQUIPMENT and ME systems

(See IEC 60601-1-2:2007, Chapter 6.8.3.201 a) 6)

Guidance and manufacturer’s declaration - electromagnetic immunity			
LokoStation / LokoStation ELVETA is intended for use in the electromagnetic environment specified below. The customer or user of the LokoStation / LokoStation ELVETA should assure that it is used in such an environment.			
IMMUNITY test IEC 61000-4-2Stor	IEC 60601-test level IEC 61000-4-2	Compliance level	Electromagnetic environment - guidance
Electrostatic discharge (ESD) IEC 61000-4-2	± 6 kV contact ± 8 kV air	± 6 kV contact ± 8 kV air	Floors should be wood, concrete or ceramic tile. If floors are covered with synthetic material, the relative humidity should be at least 30 %.
Electrical fast transient/burst IEC 61000-4-4	± 2 kV for power supply lines ± 1 kV input/output lines	± 2 kV for power supply lines ± 1 kV input/output lines	Mains power quality should be that of a typical commercial or hospital environment.
Surge IEC 61000-4-5	± 1 kV line(s) to line(s) ± 2 kV line(s) to earth	± 1 kV line(s) to line(s) ± 2 kV line(s) to earth	Mains power quality should be that of a typical commercial or hospital environment.

Guidance and Manufacturer’s declaration

Voltage dips, short interruptions and voltage variations on power supply input lines IEC 61000-4-11	< 5 % UT (>95 % dip in UT) for ½ cycle 40 % UT (60 % dip in UT) for 5 cycle 70 % UT (30 % dip in UT) for 25 cycle < 5 % UT (>95 % dip in UT) for 5 s	< 5 % UT (>95 % dip in UT) for ½ cycle 40 % UT (60 % dip in UT) for 5 cycle 70 % UT (30 % dip in UT) for 25 cycle < 5 % UT (>95 % dip in UT) for 5 s	Mains power quality should be that of a typical commercial or hospital environment. If the user of the LokoStation / LokoStation ELVETA requires continued operation during power mains interruptions, it is recommended that the LokoStation / LokoStation ELVETA be powered from an uninterruptible power supply or a battery.
Power frequency (50/60 Hz) magnetic field IEC 61000-4-8	3 A/m	3 A/m	Power frequency magnetic fields should be at levels characteristic of a typical location in a typical commercial or hospital environment.
NOTE UT is the a.c. mains voltage prior to application of the test level.			

Guidance and MANUFACTURER’S declaration - electromagnetic IMMUNITY - for ME EQUIPMENT and ME SYSTEMS that are not LIFE-SUPPORTING (see 6.8.3.201. b)

Guidance and manufacturer's declaration - electromagnetic immunity			
LokoStation / LokoStation ELVETA is intended for use In the electromagnetic environment specified below. The customer or the user of the LokoStation / LokoStation ELVETA should assure that it is used in such an environment.			
IMMUNITY test	IEC 60601-test level	Compliance level	Electromagnetic environment - guidance
			Portable and mobile RF communications equipment should be used no closer to any part of the LokoStation / LokoStation ELVETA, including cables, than the recommended separation distance calculated from the equation applicable to the frequency of the transmitter. Recommended separation distance:
Conducted RF IEC 61000-4-6	3 Vrms 150 kHz to 80 MHz	3 Vrms	$d = 1,17 \cdot 1/V^* \cdot \sqrt{P}$
Radiated RF IEC 61000-4-3	3 V/m 80 MHz to 2,5 GHz	3 V/m	$d = 1,17 \cdot 1/V^* \cdot \sqrt{P}$ for 80 MHz to 800 MHz

Guidance and Manufacturer’s declaration

			<p>$d = 2,33 \text{ m}/V*\sqrt{P}$ for 800 MHz to 2,5 GHz where P is the maximum output power rating of the transmitter in watts (W) according to the transmitter manufacturer and d is the recommended separation distance in meters (m).</p> <p>Field strengths from fixed RF transmitters, as determined by an electromagnetic site survey, should be less than the compliance level in each frequency range.</p> <p>Interference may occur in the vicinity of equipment marked with the following symbol:</p> 
<p>NOTE 1 At 80 MHz and 800 MHz, the higher frequency range applies.</p> <p>NOTE 2 These guidelines may not apply in all situations. Electromagnetic propagation is affected by absorption and reflection from structures, objects and people.</p>			
<p>a Field strengths from fixed transmitters, such as base stations for radio (cellular/cordless) telephones and land mobile radios, amateur radio, AM and FM radio broadcast and TV broadcast cannot be predicted theoretically with accuracy. To assess the electromagnetic environment due to fixed RF transmitters, an electromagnetic site survey should be considered. If the measured field strength in the location in which the LokoStation / LokoStation ELVETA is used exceeds the applicable RF compliance level above, the LokoStation / LokoStation ELVETA should be observed to verify normal operation. If abnormal performance is observed, additional measures may be necessary, such as reorienting or relocating the LokoStation / LokoStation ELVETA.</p> <p>b Over the frequency range 150 kHz to 80 MHz, field strengths should be less than 3 V/m.</p>			

Recommended separation distances between portable and mobile RF communications equipment and the ME Equipment or ME SYSTEM - for LIFE-SUPPORTING ME EQUIPMENT and ME SYSTEMS
 (See 6.8.3.201 b)

Recommended separation distances between portable and mobile RF communications equipment and the LokoStation / LokoStation ELVETA			
LokoStation / LokoStation ELVETA is intended for use in an electromagnetic environment in which radiated RF disturbances are controlled. The customer or the user of the LokoStation / LokoStation ELVETA can help prevent electromagnetic interference by maintaining a minimum distance between portable and mobile RF communications equipment (transmitters) and the LokoStation / LokoStation ELVETA as recommended below, according to the maximum Output power of the communications equipment.			
Rated maximum output power of transmitter (Watt)	Separation distance according to frequency of transmitter (m)		
	150 kHz to 80 MHz $d = 1,17 \text{ m}/V*\sqrt{P}$	80 MHz to 800 MHz $d = 1,17 \text{ m}/V*\sqrt{P}$	800 MHz to 2,5 GHz $d = 2,33 \text{ m}/V*\sqrt{P}$
0,01 W	0,12 m	0,12 m	0,23 m
0,1 W	0,37 m	0,37 m	0,74 m
1 W	1,17 m	1,17 m	2,33 m
10 W	3,69 m	3,70 m	7,37 m
100 W	11,67 m	11,7 m	23,3 m
For transmitters rated at a maximum output power not listed above, the recommended separation distance in meters (m) can be determined using the equation applicable to the frequency of the transmitter, where P is the maximum output power rating of the transmitter in watts (W) according to the transmitter manufacturer.			
<p>Note 1 At 80MHz und 800 MHz, the separation distance for the higher frequency range applies.</p> <p>Note 2 These guidelines may not apply in all situations. Electromagnetic propagation is affected by absorption and reflection from structures, objects and people.</p>			

Incident Report

12 Incident Report

According to European Medical Device Regulation (MDR 2017/745) Vigilance Reporting Requirements and MEDDEV 2.12-1

Reporting of a suspected serious incident:

The user and / or patient must report all serious incidents that occur in connection with the product to the manufacturer and the competent authority of the EU member state in which the user and / or patient is resident.

By reporting a suspected serious incident, you can help obtain more information about the safety of this device.

13 Disposal

The disposal of the equipment must be in accordance with the respective national regulations.

Electrical and electronic devices must be disposed of separately from normal household waste.

An appropriate waste disposal company should be contacted. Properly dispose of the device at the end of its service life (e.g. the local collection point for waste separation):

- The device packaging is disposed of through resource recycling.
- The metal parts of the machine go to scrap metal disposal.
- Plastic parts are given to plastic recycling.
- Electric components and printed circuit boards are disposed of as electronic scrap.
- Rubber parts are disposed of as hazardous waste.



	<p>This symbol indicates electrical and electronic equipment that cannot be disposed of with standard waste, but must be handled separately.</p> <p>Disposal must be carried out to prevent problems with heavy metals and flame retardants in accordance with relevant waste management.</p> <p>Please contact the manufacturer's authorized representative in order to obtain information concerning disposal of your equipment.</p>
	<p>The disposal of the equipment must be in accordance with the respective national regulations.</p> <p>Wear parts are considered hazardous waste! After being replaced wear parts must be disposed of according to country-specific waste laws.</p>

Table of Figures

14 Table of Figures

Fig. 1 EU Declaration of Conformity, LokoStation 9

Fig. 2 EU Declaration of Conformity, LokoStation ELVETA 10

Fig. 3 Nameplate, LokoStation 19

Fig. 4 Nameplate, LokoStation ELVETA 19

Fig. 5 Nameplate, Patient Harness 20

Fig. 6 Dimensions and Weights 21

Fig. 7 Device Components 25

Fig. 8 Wheelchair Ramp 30

Fig. 9 Rope Width Adjustment 32

Fig. 10 Adjusting the Width 32

Fig. 11 Locking Pins, Body Weight Support 33

Fig. 12 Main Winch Crank 33

Fig. 13 ELVETA Remote Control 34

Fig. 14 Preparing the Dynamic Body Weight Support 35

Fig. 15 Adjusting the Dynamic Body Weight Support 36

Fig. 16 ELVETA Remote Control 37

Fig. 17 ELVETA Drive, Control Elements 38

Fig. 18 Emergency Lowering Switch 39

Fig. 19 Therapist Seats 40

Fig. 20 Rope Length Adjustment 40

Fig. 21 Rope Length Adjustment 41

Fig. 22 Rope Return Stop 42

Fig. 23 ELVETA, Two-Sided Rope Length Adjustment 42

Fig. 24 ELVETA, Adjustable Rope Lengths 43

Fig. 25 Safety Belt Buckles 44

Fig. 26 Hip Stabilization 47

Fig. 27 Fastening the Harness 48